

Soggiorno

Camera

Bagno

Led

Cucina



STRIP LED FLEX



Barra flessibile completa di profilo in gomma trasparente e isolante con supporto adesivo - 24V - °K 5000

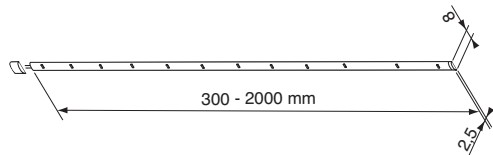
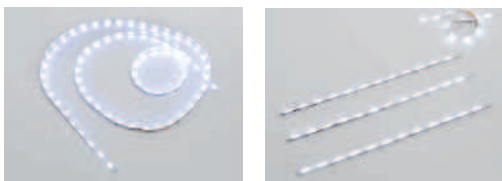

In fila continua - max 3 x 2000 - max 20 x 300

n° LED	colore	W	L=mm	Art.	€
12	bianco	0,8	300	12802790100	20,00
12	blu	0,8	300	12802791600	18,00
72	bianco	4,9	2000	12802800100	118,00
72	blu	4,9	2000	12802801600	106,00



Connettore "T" 24V per strip led flex



n° LED	colore	W	L=mm	Art.	€
6	bianco	0,4	160	12803070100	12,00
6	blu	0,4	160	12803071600	11,00



Alimentatori completi di distributore 6 vie - 220/240 - V 24

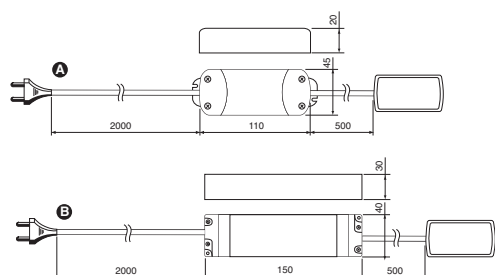

	Hz	W	Art.	€
A	50	max 15	12501280100	33,00
B	50/60	max 30	12502910100	62,00

Prolunga di alimentazione tra barre LED e distributore

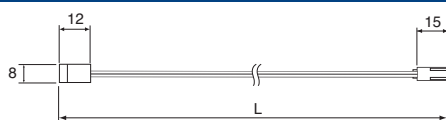

L=mm	Art.	€
1000	12803020100	3,00
2000	12803030100	4,00
4000	12803440100	5,50

Cavo di connessione intermedia tra barre LED

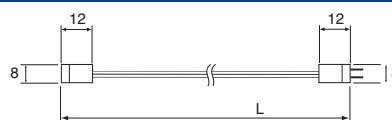

L=mm	Art.	€
40	12803040100	1,50
100	12803050100	2,00
500	12803060100	2,50

STRIP LED FLEX RGB CROMOTERAPIA



Barra RGB flessibile **24V** a LED completa di profilo in gomma trasparente e isolante con supporto adesivo

NEW

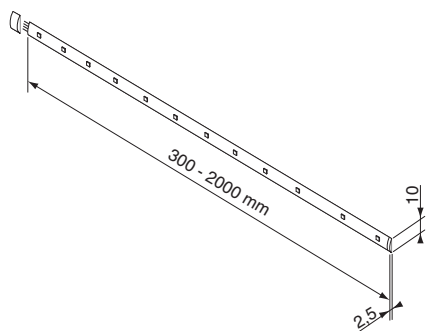

n° LED	W	L=mm	Art.	€
12	1,8	300	12803370000	45,00
72	10,8	2000	12802820000	345,00

Alimentatori per barre LED RGB completi di distributore 4 uscite e sequenzer - 220/240 - 24V

Funzionamento sequenzer:

- 1° bip: acceso
- 1 bip: selezione colore fisso
- 2 bip: cambia colore automaticamente
- 3 bip: cambia colore automaticamente fluttuando
- 4 bip: spento

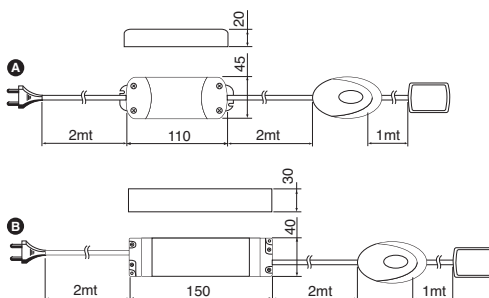

	W	Art.	€
A	max 15	12503030100	69,00
B	max 30	12503040100	103,00

Prolunga di alimentazione tra barre LED RGB e distributore

L=mm	Art.	€
1000	12803210100	5,00
2000	12803220100	6,00
4000	12803450100	9,00

Cavo di connessione intermedia tra barre LED RGB

L=mm	Art.	€
40	12803230100	3,00
500	12803240100	3,50

STRIP LED/ STRIP LED HE



STRIP LED

Barra da 10 LED completa di scocca in plastica trasparente isolante W 0,7 - 12V - L= mm 250 - K° 5100

LED DI SEGNALAZIONE

N.B: per un'ottima resa max 18 barre per uscita
- max 4,5 m per uscita

colore	Art.	€
bianco	128002700	24,00
blu	128002800	18,00
rosso	128002900	18,00
verde	128003000	24,00
giallo	128003100	18,00



STRIP LED HE

Barre LED ad alta efficienza complete di scocca in alluminio e lente - 12V - K° 5100

LED DI ILLUMINAZIONE

N.B: per un'ottima resa max 6 barre per uscita - max 1,5 m per uscita

n° LED	W	L=mm	K°	Art.	€
12	0,8	125	5100	128020000	16,00
24	1,65	250	5100	128020100	30,00
12	0,8	125	3200	128027100	18,00
24	1,65	250	3200	128027200	33,00

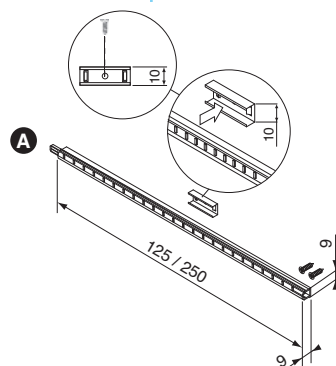

CONNESSIONI

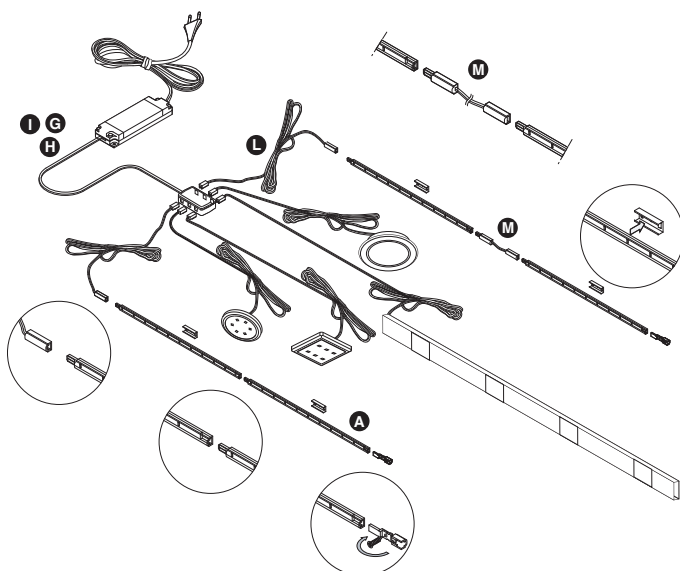

M CAVETTO PONTE

mm 30	128002401	€ 1,50
mm 300	128002501	€ 2,00
mm 1500	128002601	€ 3,00

L PROLUNGA TRA BARRA E MINI D

mm 1000	128003201	€ 2,50
mm 2000	128003301	€ 3,50
mm 4000	128017701	€ 6,50

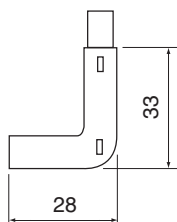
CONNETTORE AD L PER STRIP LED 2 LED - 0,12 W - 12 V

colore	Art.	€
bianco	128010900..	6,00
blu	128011200..	6,00
rosso	128011100..	5,00
verde	128011300..	6,00
giallo	128011000..	5,00

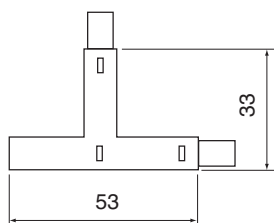
CONNETTORE AD T PER STRIP LED 2 INGRESSI - 3 LED - 0,18 W - 12 V

colore	Art.	€
bianco	128009900..	8,00
blu	128010200..	7,00
rosso	128010100..	6,00
verde	128010300..	9,00
giallo	128010000..	6,00

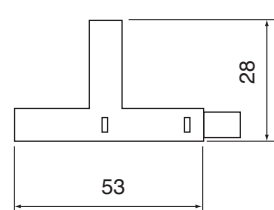
CONNETTORE AD T PER STRIP LED 2 USCITE - 2 LED - 0,12 W - 12 V

colore	Art.	€
bianco	128010400..	6,50
blu	128010700..	6,00
rosso	128010600..	6,00
verde	128010800..	7,00
giallo	128010500..	6,00

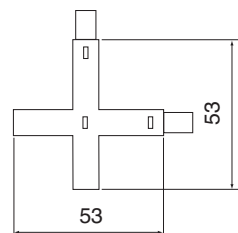
CONNETTORE AD X PER STRIP LED 3 LED - 0,18 W - 12 V

colore	Art.	€
bianco	128009400..	8,00
blu	128009700..	8,00
rosso	128009600..	7,00
verde	128009800..	10,00
giallo	128009500..	7,00

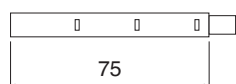
MINI STRIP LED 3 LED - 0,18 W - 12 V

colore	Art.	€
bianco	128011400..	7,00
blu	128011700..	5,00
rosso	128011600..	5,00
verde	128011800..	7,00
giallo	128011500..	5,00

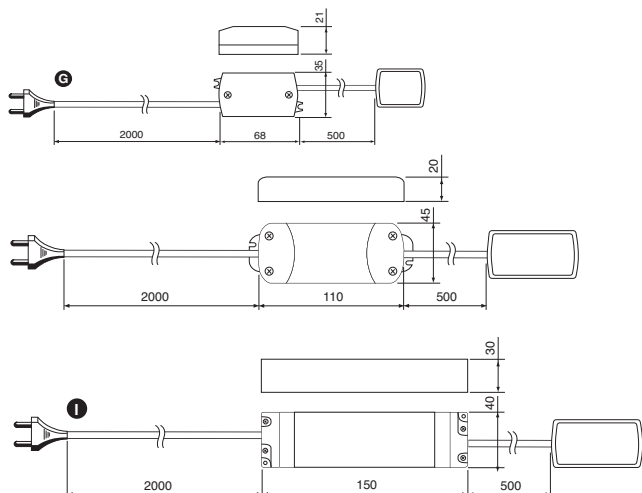
ALIMENTATORI COMPLETI DI DISTRIBUTORE 220/240 - V 12 DC

	uscite	Hz	Art	W	€
G	4	50	125028801..	0,5-6 (7 strip-125 mm) (3 strip-250 mm)	27,00
H	6	50	125005601..	Max 15 (18 strip-125 mm) (9 strip-250 mm)	33,00
I	6	50/60	125008501..	Max 30 (37 strip-125 mm) (18 strip-250 mm)	51,00

STRIP LED RGB - CROMOTERAPIA



Barra a 9 LED RGB completa di profilo in plastica trasparente isolante - 12V.

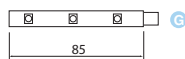
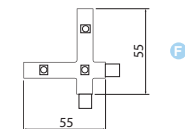
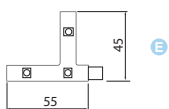
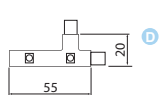
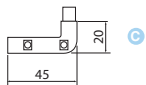
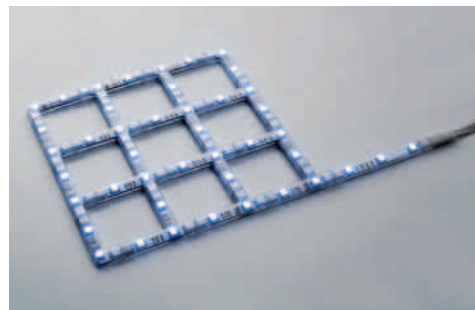
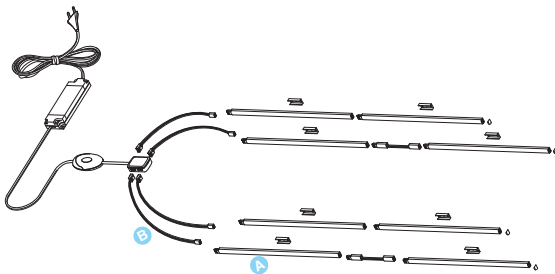
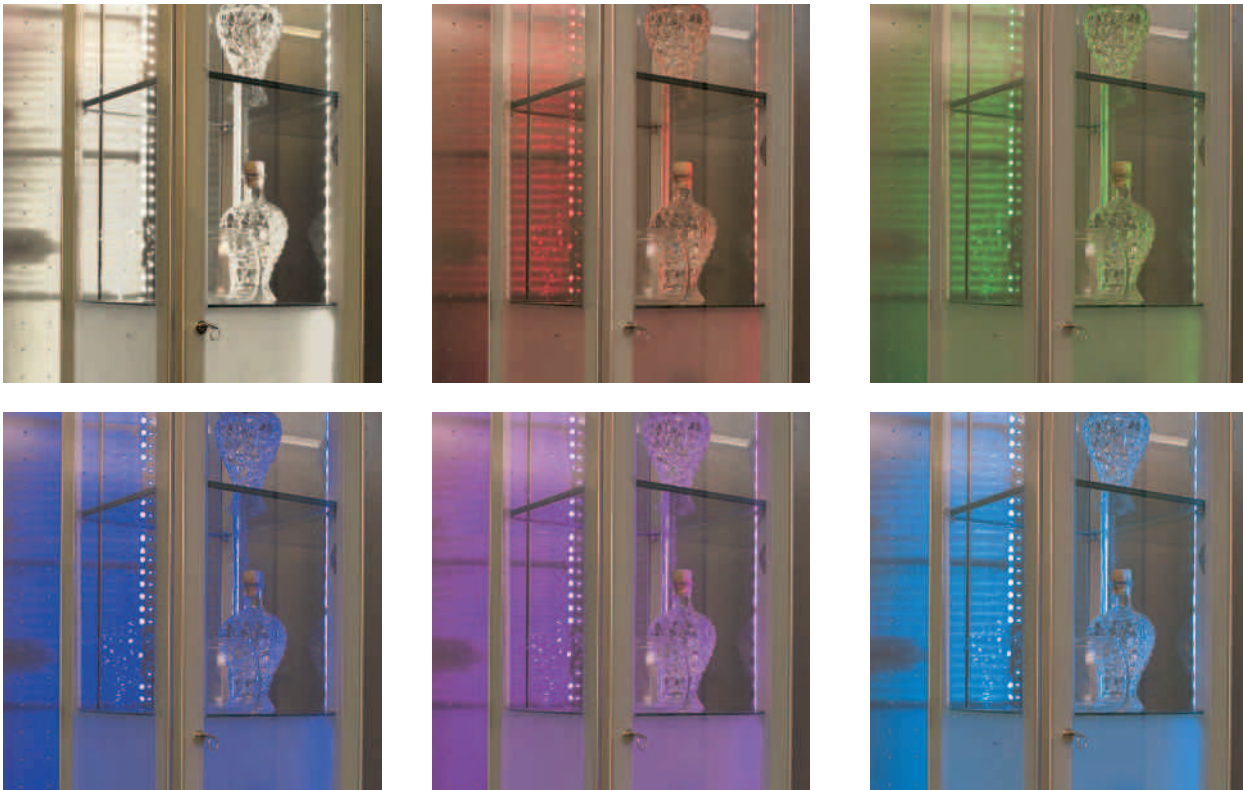

- Descrizione
- A** Strip LED RGB
 - G** Mini strip LED RGB
 - C** Connettore "L"
 - D** Connettore "T" 2 uscite
 - E** Connettore "T" 2 ingressi
 - F** Connettore "X"

W	L=mm	Art.	€
1,7	250	128003600..	60,00
0,9	85	128012300..	16,00
0,6	--	128012200..	13,50
0,9	--	128012000..	11,75
0,6	--	128012100..	18,00
0,9	--	128011900..	18,50

STRIP LED RGB - CONNESSIONE RAPIDA

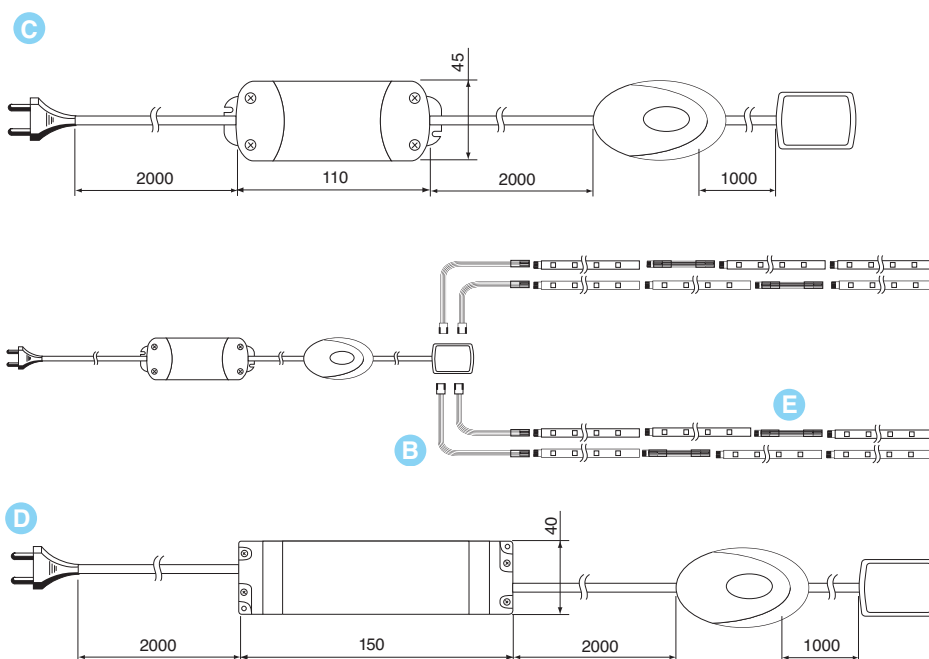

Descrizione

- C** Alimentatore a spina con distributore a 4 vie
- D** Alimentatore a spina con distributore a 4 vie
- E** Cavetto ponte
- E** Cavetto ponte
- E** Cavetto ponte
- B** Prolunga di connessione tra la barra led e il Mini-D
- B** Prolunga di connessione tra la barra led e il Mini-D

W	V	L=mm	Art.	€
15	220-240	--	125006101..	55,00
30	220-240	--	125008701..	72,00
--	--	40	128003701..	2,50
--	--	1000	128003801..	4,00
--	--	2000	128003901..	4,00
--	--	1000	128004001..	3,00
--	--	2000	128004101..	4,00

ACCESSORI PER STRIP LED (PER TUTTI I MODELLI)

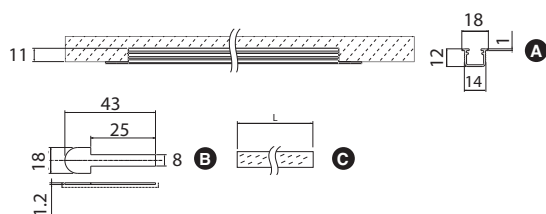
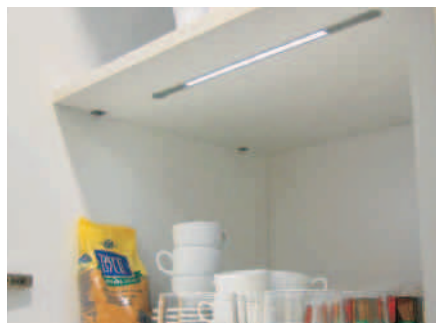
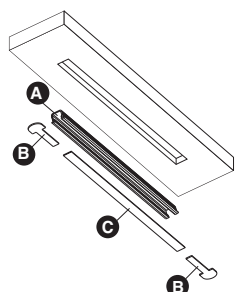

- A** Profilo in alluminio
- A** Profilo in alluminio
- B** Testate (coppia)
- C** Schermo
- C** Schermo

L=mm	Art.	€
1000	157003412..	10,00
2000	157001112..	19,50
--	124039610..	15,50
1000	122005401..	5,50
2000	122005501..	10,00

STRIP LED FLEX IP64



Barra a LED flessibile con grado di protezione contro la penetrazione di acqua e polvere IP64. Grazie al suo profilo in gomma trasparente ed isolante il prodotto è indicato per l'applicazione in ambienti umidi - **24V**.

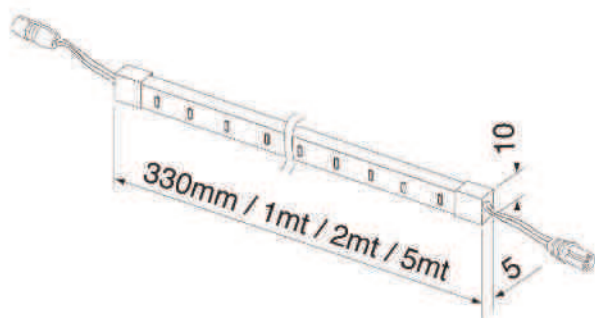

N° LED	Color	°K	W	VDC	lux(*)	L=mm	Art.	€
12	bianco	5000	0,8	24	---	330	12805100100	53,00
36			2,5		---	1000	12805110100	140,00
72			5		---	2000	12805120100	274,00
198			13,5		---	5000	12805180100	649,00

AC/DC POWER SUPPLY (24V) 220-240V

Alimentatore per Strip LED Flex IP64

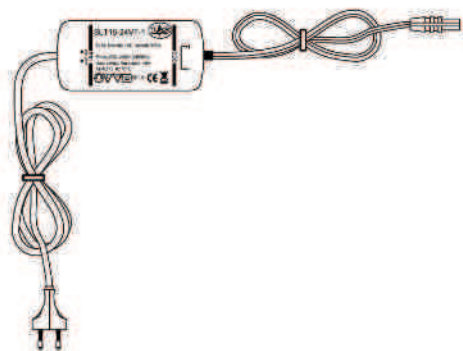

Pri		Sec			Art.	€
V	Hz	V	A	W		
	50	24DC	max 0,624	max 15	12504110100	49,50



INFINITY

La sorgente luminosa incorporata è una lampada fluorescente elettronica che risponde ai requisiti di basso consumo energetico e lunga durata della vita del prodotto.

La sostituzione del tubo T5 è facilitata dalla semplice rimozione frontale del vetro.

La luce si diffonde armoniosamente su tutto il piano di lavoro.

La parte superiore si estende orizzontalmente formando una mensola che costituisce un facile appoggio per oggetti estetici e di uso pratico quotidiano.

Ruotando il piano superiore della mensola si accede a comodi vani/contenitori dove possono trovare alloggio oggetti vari.

Presa ed interruttore sono predisposti all'interno della mensola e compaiono alla vista solo all'occorrenza.

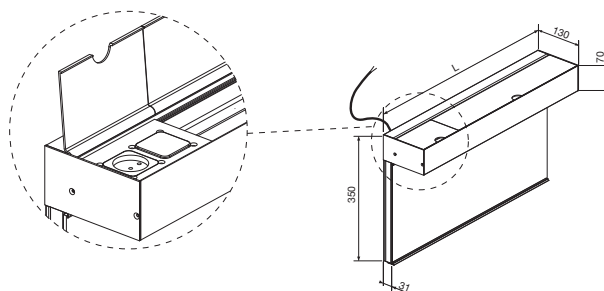

W	L= mm	ALLUMINIO		ACCIAIO INOX SPAZZOLATO	
		Art.	€	Art.	€
8	450	142000112	373,00	142000191	408,00
13	600	142000212	404,00	142000291	447,00
21	900	142000312	478,00	142000391	530,00
28	1200	142000412	555,00	142000491	626,00
35	1500	142000512	620,00	142000591	707,00
		Guarnizione A mm 2500		124025400	€ 23,00

ETERNITY

La sorgente luminosa incorporata è una lampada fluorescente elettronica a basso consumo energetico e lunga durata della vita del prodotto.

La sostituzione del tubo T5 è facilitata dalla semplice rimozione frontale del vetro.

La luce si diffonde armoniosamente su tutto il piano di lavoro.

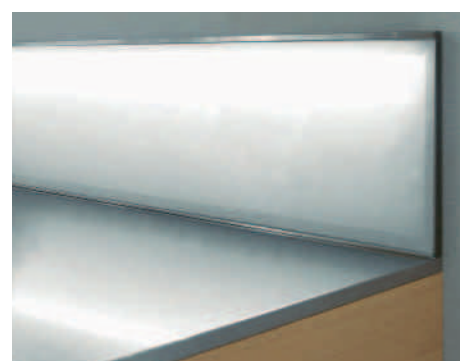
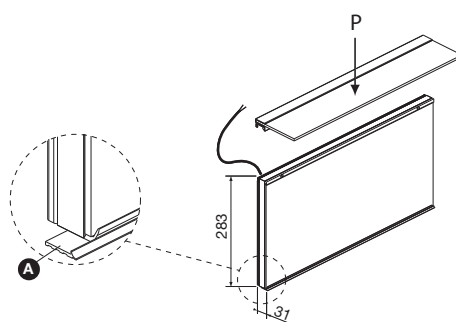

		ALLUMINIO		ACCIAIO INOX SPAZZOLATO		OPTIONAL	
						MENSOLA CRISTALLO/ALLUMINIO	
W	L= mm	Art.	€	Art.	€	Art.	€
8	450	142000612	201,00	142000691	223,00	142004012	34,00
13	600	142000712	226,00	142000791	247,00	142004112	37,00
21	900	142000812	270,00	142000891	304,00	142004212	57,00
28	1200	142000912	320,00	142000991	363,00	142004312	69,00
35	1500	142001012	360,00	142001091	413,00	142004412	82,00
		Guarnizione A mm 2500		124025400	€ 23,00		

BOSTON

DAYTONA LED

Fondo in alluminio e vetro per elemento pensile con fianchi 18 mm
Completo di cavo di alimentazione e bussole di fissaggio ai fianchi del pensile regolabili in profondità ed in due posizioni di altezza, profilo frontale estraibile, interruttore.

- per anta con maniglia **A**
- per anta senza maniglia **B**
- per anta con o senza maniglia **C**

Con illuminazione fluorescente elettronica



H. 30,5 mm.

A	L=mm	W	Art.	€
	600	13	134001012	182,00
	900	13	134001112	186,00

B	L=mm	W	Art.	€
	600	13	134005312	211,00
	900	13	134005412	217,00



Con illuminazione LED HE

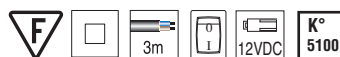

H. 21,0 mm.

C	n° LED	L=mm	W	Art.	€
	48	450	3,2	16200011200	196,00
	72	600	4,8	16200021200	243,00
	120	900	8,0	16200031200	322,00
	144	1200	9,6	16200041200	384,00

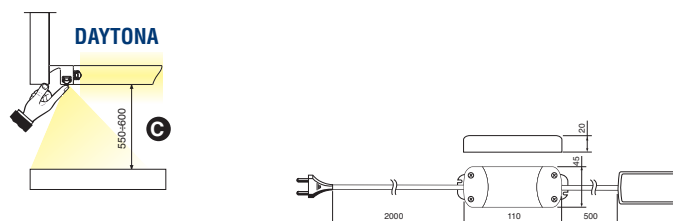

uscite	Hz	Art	W	€
6	50	125005601..	Max 15	33,00

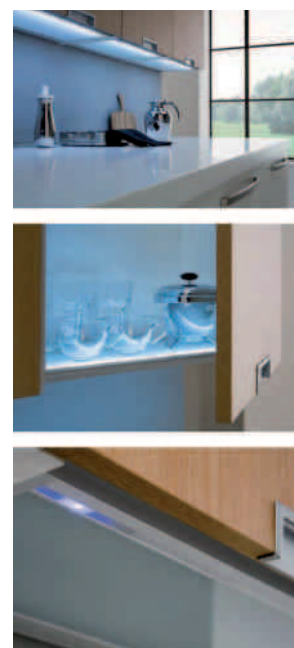

CALIFORNIA



Mensola alluminio finitura **acciaio spazzolato** con illuminazione fluorescente elettronica, cavo alimentazione mt. 3 presa e interruttore. Predisposta per accessori. Portata massima 3 kg per 10 cm.



L=mm	W	Art.	€
600	8	138000191..	245,00
900	13	138000291..	284,00
1200	21	138000391..	333,00
1500	28	138000491..	387,00

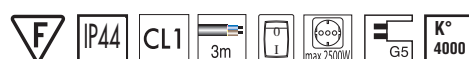
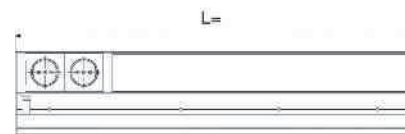
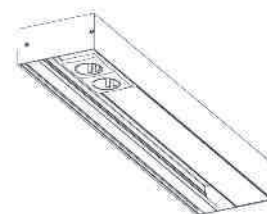
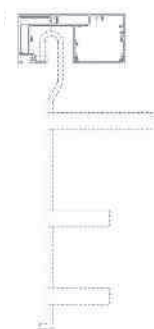
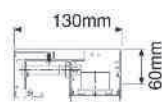

TEKNO



Mensola in alluminio e vetro temperato con illuminazione fluorescente elettronica. Portata massima consentita 1,5 Kg ogni 10 cm di lunghezza della lampada.

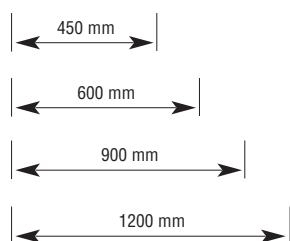
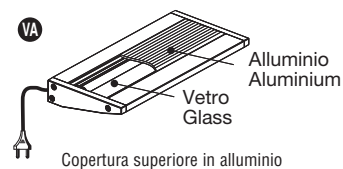
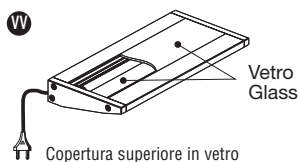
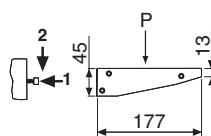

	VV Art.	€	VA Art.	€
8W	2338712-25-04	188,00	2338812-25-04	170,00
13W	2337812-25-04	203,00	2338112-25-04	187,00
21W	2337912-25-04	234,00	2338212-25-04	222,00
28W	2338012-25-04	277,00	2338312-25-04	266,00

DENVER

Mensola in vetro temperato ed alluminio con illuminazione fluorescente elettronica, grazie alla sua forma Denver rappresenta un complemento d'arredo che rende più gradevole l'ambiente.

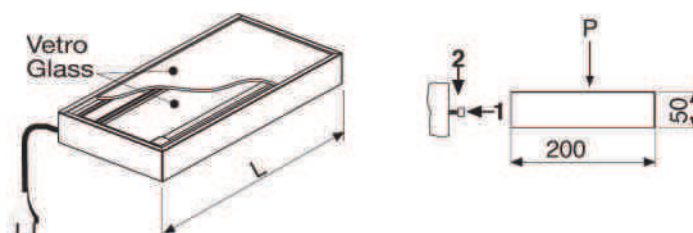

Ref.	Versione	P= Kg/100mm	W	V	L=mm	Art.	€
		2	8	230	450	16300011200	118,50
		2	8		600	16300021200	134,00
		1,5	13		900	16300031200	169,00
		1,5	21		1200	16300041200	216,50

MEMPHIS



Mensola in alluminio e vetro temperato con illuminazione fluorescente elettronica. Portata massima consentita 1,5 Kg ogni 10 cm di lunghezza della lampada.

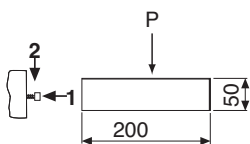

450 mm

600 mm

900 mm

1200 mm

	W	Art.	€
	8W	2351012-25.03	188,00
	13W	2351112-25.03	205,00
	21W	2351212-25.03	253,00
	28W	2351312-25.03	303,00

MALIBÙ

Mensola in vetro temperato ed alluminio con incorporata lampada fluorescente elettronica. Portata max 2 kg / 10 cm (cm 500 e 600) 1,5 kg / 10 cm (900) 1 kg / 10 cm (1200).

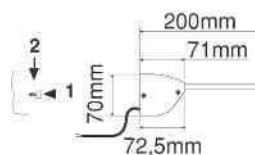
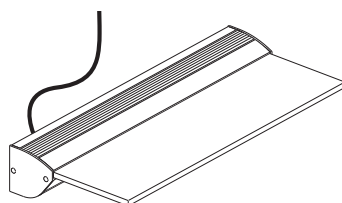
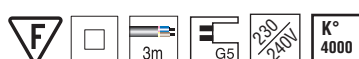

CON INTERRUTORE

L=mm	Watt	Art.	€
500	8	136000112..	134,50
600	13	136000212..	143,00
900	21	136000312..	173,50
1200	28	136000412..	216,00

SENZA INTERRUTORE

L=mm	Watt	Art.	€
500	8	136000512..	122,00
600	13	136000612..	130,50
900	21	136000712..	161,00
1200	28	136000812..	203,00

MONACO LED

Mensola in vetro temperato ed alluminio con incorporata "barra LED". Portata 0,5 kg /10 cm

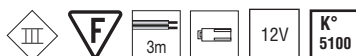
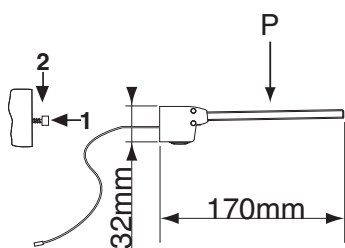

CON STRIP LED

L=mm	n° LED	W	Art.	€
450	10	0,7	155000112	114,50
600	20	1,4	155000212	139,00
900	30	2,1	155000312	183,00
1200	40	2,8	155000412	219,50



SLT ALIMENTATORE CABLATO CON DISTRIBUTORE A 6 VIE

Max 15 W - 125005601	€ 33,00
Max 30 W - 125008501	€ 57,00

MIAMI

Lampada in alluminio con illuminazione fluorescente elettronica completa di schermo di protezione.

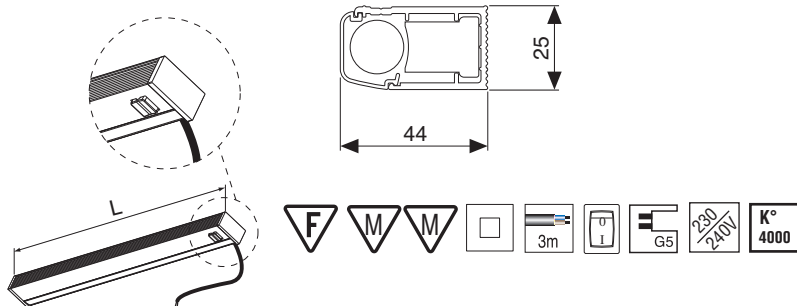

W	L= mm	Art.	€
8	450	135000412..	98,00
13	600	135000512..	114,00
13	900	135000612..	116,00
21	1200	135000712..	130,00

MIAMI-C



Lampada in alluminio con illuminazione fluorescente elettronica ed accensione automatica. **Indicata per applicazioni su elementi "cestoni"**

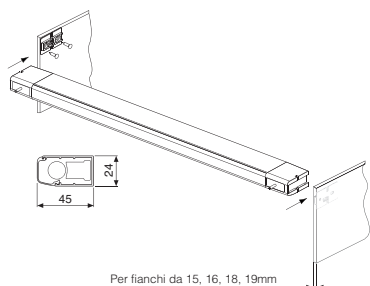

W	L= mm	Art.	€
8	563	135014712..	102,00
13	863	135014812..	118,00
21	1163	135014912..	136,00

MIAMI-S

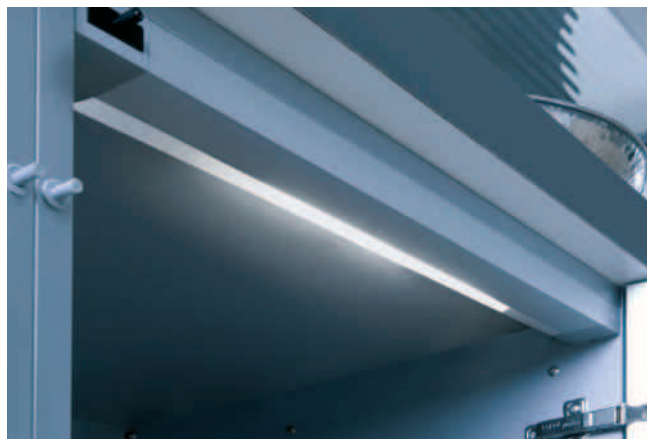

Lampada in alluminio con illuminazione fluorescente elettronica ed accensione automatica. **Indicata per applicazione in basi per anta.**

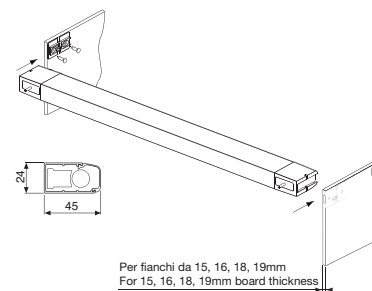

W	L= mm	Art.	€
8	563	135015012..	105,00
13	863	135015112..	133,00
21	1163	135015212..	153,00

DETROIT - C

Barra in alluminio LED HE, **12 V** con interruttore infrarad e controllo della temperatura integrato. **Indicato per applicazioni su elementi "cestoni"**.

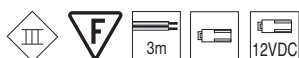
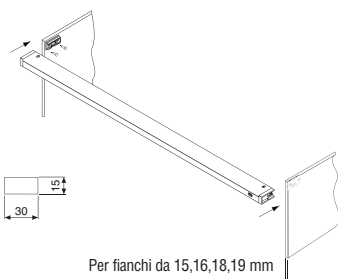

N°LED	W	L= mm	Art.	€
24	1,65	450	16000011200	96,00
36	2,4	600	16000021200	115,00
72	5	900	16000031200	160,00
96	6,6	1200	16000041200	201,00



DETROIT - S

Barra in alluminio LED HE, **12 V** con interruttore infrarad e controllo della temperatura integrato. **Indicato per applicazioni su elementi "basi"**.

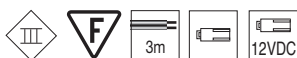
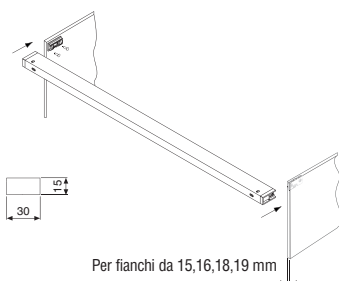

N°LED	W	L= mm	Art.	€
24	1,65	450	16000051200	100,00
36	2,4	600	16000061200	118,00
72	5	900	16000071200	178,00
96	6,6	1200	16000081200	216,00



ALIMENTATORI COMPLETI DI DISTRIBUTORE

220/240 - V 12 DC

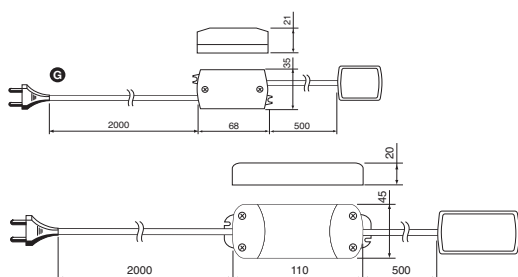

	uscite	Hz	Art	€
G	4	50	125028801..	27,50
H	6	50	125005601..	33,00

CAMILLA

Lampada in policarbonato con illuminazione fluorescente elettronica, con in dotazione n° 2 clips per il fissaggio sul telaio "elemento scolapiatti".

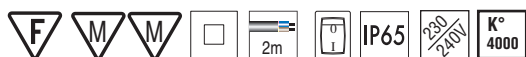
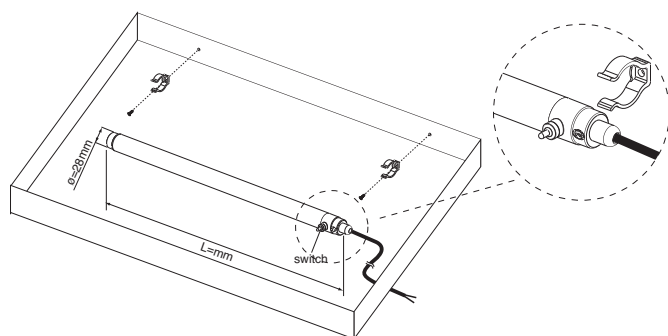

W	L= mm	Art.	€
8	500	137000100..	75,00
13	730	137000200..	81,00



MILLENIUM

Lampada in alluminio con illuminazione fluorescente elettronica con in dotazione staffe per fissaggio



W	L= mm	Art.	€
8	600	2332612..	118,00
13	900	2332712..	135,00
21	1200	2332812..	160,00



Lampada fluorescente elettronica, inserita in un profilo angolare di alluminio estruso, 230/240V att. G5, completa di presa Schuko, interruttore e cavo di alimentazione L=2 mt.





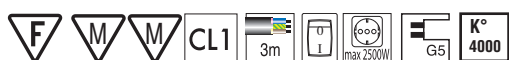

CORNER PI con presa

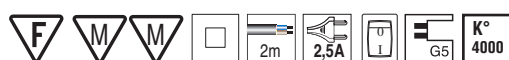

CORNER FC senza presa

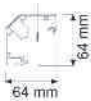
Predisposta per fila continua.









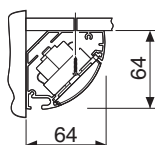

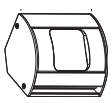

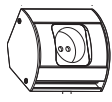

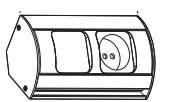
	PI CON PRESA				FC SENZA PRESA			
	L = mm	W	Art.	€	L = mm	W	Art.	€
	423 mm	8	108001412..	89,00	329 mm	8	108001012..	82,00
	652 mm	13	108001512..	101,00	558 mm	13	108001112..	92,00
	984 mm	21	108001612..	129,00	890 mm	21	108001212..	114,00
	1283 mm	28	108001712..	155,00	1190 mm	28	108001312..	148,00

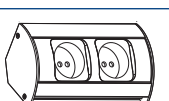
INTERRUTTORI E PRESE

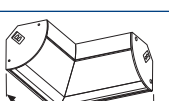
Profili modulari angolari in alluminio, 230-240V, max 2500W.



	INTERRUTTORE	 
	L.93 mm- Art. 108006512	€ 36,00
	PRESA SINGOLA SCHUKO	 
	L.93 mm- Art. 108005012	€ 34,00
	INTERRUTTORE + PRESA SCHUKO	 
	L.150 mm- Art. 108005112	€ 50,00
	PRESA DOPPIA SCHUKO	 
	L.150 mm- Art. 108003412	€ 46,00
	ANGOLO 90°	   
	L.150x150 mm- Art. 108004812	€ 82,00

CORNER EVOLUTION

Lampada in alluminio con illuminazione fluorescente elettronica predisposta per portaccessori Kessemböhmer e presa schuko integrata. Un concetto di luce sempre attuale con un valore costo-prestazione vincente nel mercato.

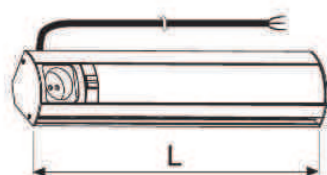
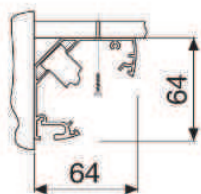

Ref.	Versione	W	V	L=mm	Art.	€
		8		423	no code	alluminio anodizzato 65,00
		8		423	no code	acciaio spazzolato 75,00
		13		652	no code	alluminio anodizzato 76,00
		13	230	652	no code	acciaio spazzolato 88,00
		21		984	no code	alluminio anodizzato 114,50
		21		984	no code	acciaio spazzolato 132,00
		28		1283	no code	alluminio anodizzato 136,00

FREEDOM

Apparecchio in materiale termoplastico con lampada fluorescente lineare T5, ballast elettronico, predisposta per connessione a filo continua con incluse clips di fissaggio e prolunga di alimentazione.



Tubo fluorescente incluso

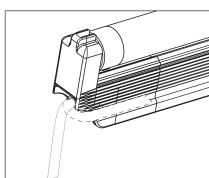
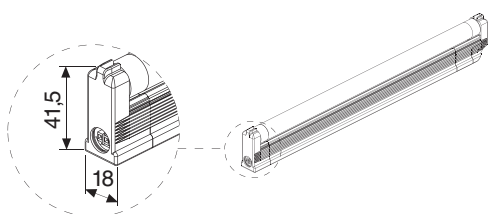
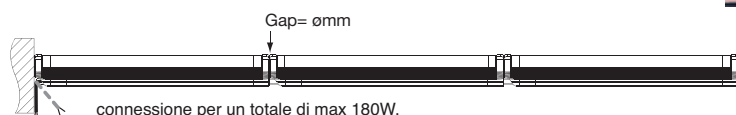

Il cavo di alimentazione ruota e rimane all'interno delle dimensioni della lampada.

FREEDOM V 07

W	L= mm	Art.	€
8	307	150000101..	50,00
13	536	150000201..	55,00
14	568	150000301..	63,00
21	868	150000401..	68,00
28	1168	150000501..	91,00
35	1468	150000601..	96,00

FREEDOM V 07-R CON RIFLETTORE

W	L= mm	Art.	€
8	307	150003101..	54,00
13	536	150003201..	59,00
14	568	150003301..	66,00
21	868	150003401..	72,00
28	1168	150003501..	95,00
35	1468	150003601..	100,00

SCHERMO e testate trasparenti



V 07

W	Art.	€
8	5133800	4,00
13	5133900	5,00
14	5134200	7,00
21	5134000	8,00
28	5134100	10,00
35	5134300	12,00

V 07 -R

W	Art.	€
8	1240385	4,00
13	1240386	5,00
14	1240387	5,00
21	1240388	6,00
28	1240389	10,00
35	1240390	11,00

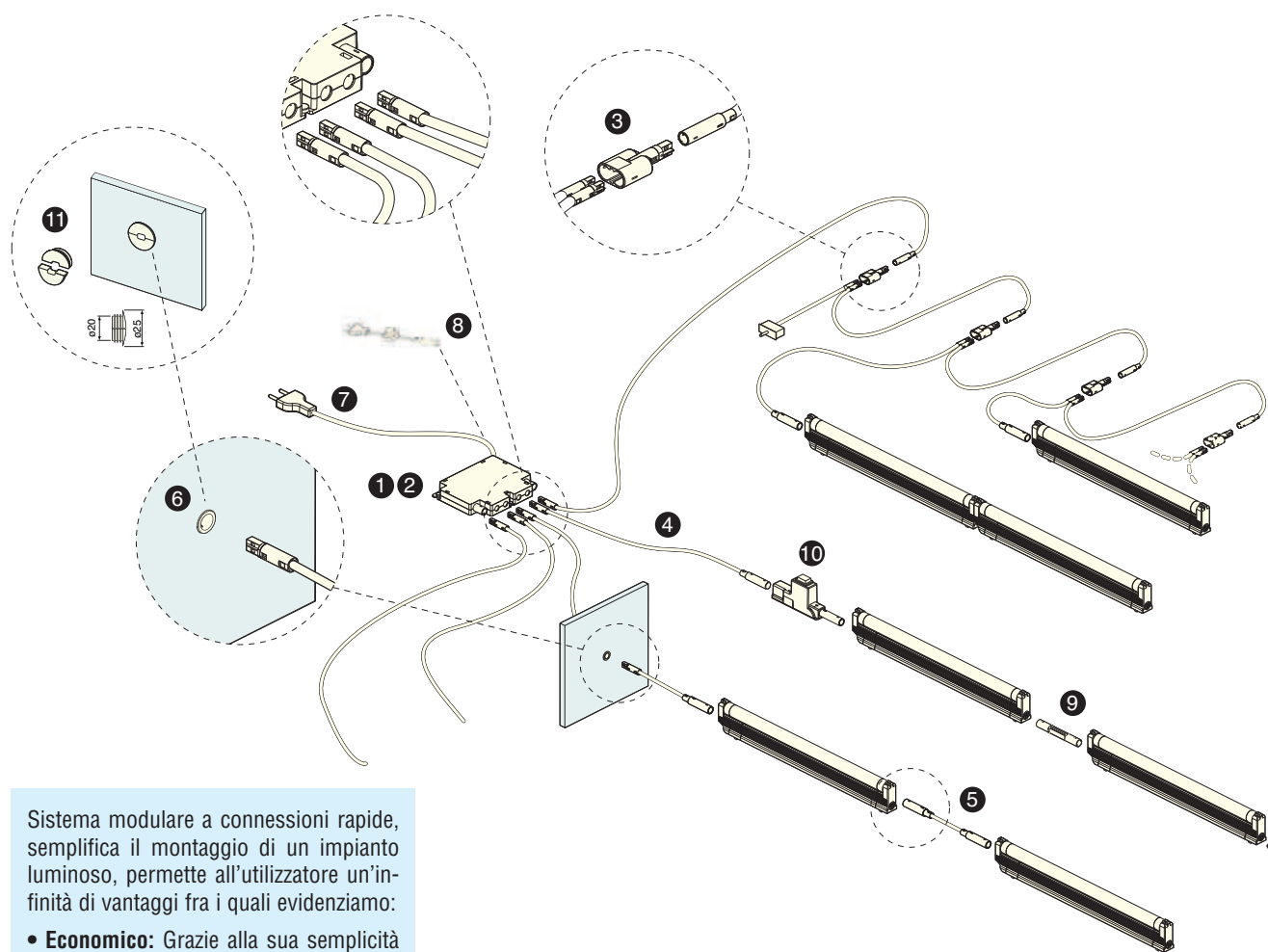

Sistema modulare a connessioni rapide, semplifica il montaggio di un impianto luminoso, permette all'utilizzatore un'infinità di vantaggi fra i quali evidenziamo:

- **Economico:** Grazie alla sua semplicità si facilita il montaggio del prodotto, si ha quindi una minore permanenza del personale in cantiere riducendo così il tempo fra l'ordine cliente e la consegna degli impianti.

- **Dimensioni:** È il più piccolo ed unico "Sistema" sul mercato, permette così una grande libertà di progettazione e versatilità d'impiego.

- **Qualità:** La certezza di avere un impianto in sicurezza e certificato (Europea e Americana). Ogni collegamento viene eseguito e garantito da L&S.

- **No Manodopera:** La totalità dei collegamenti concepita con "connessioni rapide" rende il sistema così semplice che per il suo montaggio non necessita di personale specializzato né di attrezzi.

- **Flessibilità:** Un sistema completo con numerosi accessori, concepito per rispondere alla più ampia necessità di applicazioni.

- **Impianti su misura:** Puoi con facilità soddisfare il tuo cliente con impianti personalizzati.

Descrizione	Art.		€
1 scatola di derivazione a 4 uscite	1510016..01/03	124x82x18mm	15,00
2 scatola di derivazione a 6 uscite	1510017..01/03	124x82x18mm	17,00
3 connettore ponte P	151001501	---	6,00
4 prolunga intermedia tipo "A"	1510007..01/03	0,3m	5,00
4 prolunga intermedia tipo "A"	1510008..01/03	1m	6,00
4 prolunga intermedia tipo "A"	1510009..01/03	2m	7,00
5 prolunga intermedia tipo "B"	1510004..01/03	0,3m	5,00
5 prolunga intermedia tipo "B"	1510005..01/03	1m	6,00
5 prolunga intermedia tipo "B"	1510006..01/03	2m	7,00
6 prolunga intermedia tipo "G"	1510010..01/03	1m	7,00
6 prolunga intermedia tipo "G"	1510011..01/03	2m	7,00
7 prolunga di connessione tipo "E"	1510001..01/03	2m	5,00
7 prolunga di connessione tipo "E"	1510002..01/03	3m	5,50
7 prolunga di connessione tipo "E"	1510003..01/03	4m	7,00
8 prolunga di connessione tipo "D"	1510012..01/03	2m	14,00
8 prolunga di connessione tipo "D"	1510013..01/03	4m	17,00
9 prolunga di connessione intermedia	151001801		2,50
10 interruttore bipolare c/luce	151001901		9,00
11 Tappo copriferro PK	51007..01/03	ø=25mm	0,50

HALOGEN - L

Profilo modulare metallico alluminio con lampade alogene 20W 12V att. G4 completo di trasformatore 230/12V e cavo di alimentazione. Predisposto per fila continua.

HALOGEN - L SENSOR

Stesse caratteristiche Halogen - L, ma con accensione a sensore

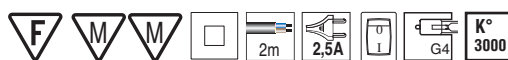

Lampada alogena inclusa
20W (codice 211300)

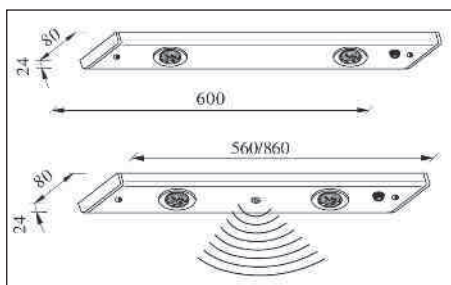

FARETTI 2 x 20 W

	L= mm	Art.	€
	600	1613312	85,00
SENSOR	560	1698112	135,00
SENSOR	860	1698212	139,00

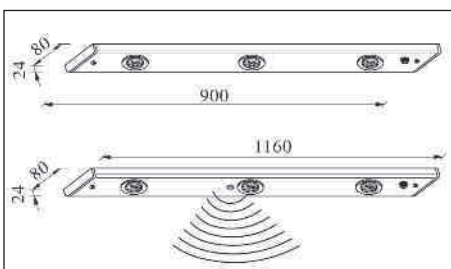

FARETTI 3 x 20 W

	L= mm	Art.	€
	900	1613412	102,00
SENSOR	1160	1698312	162,50

PROFILO copriluce in alluminio con testate di chiusura laterali



	Art.	€
Profilo 2000 mm	6814012B	68,00
Testata dx	6838612	10,00
Testata sx	6838712	10,00

PRESE modulari metalliche - schuko . Cavo 3 x 1,5 mm - 2 m - predisposte per fila continua 230V - Max 1250 W (x2)

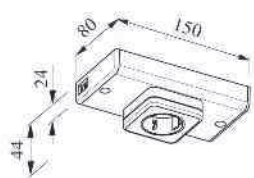

PRESA SINGOLA

colori	Art.	€
alluminio	1908612	46,00

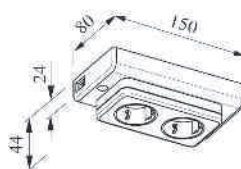

PRESA DOPPIA

colori	Art.	€
alluminio	1909112	76,00

LUMINELLA

Lampada fluorescente 230 V in materiale termo-stampato, ad alimentazione elettromeccanica con interruttore, cavo di alimentazione L=2m e spina. Predisposta per la fila continua.

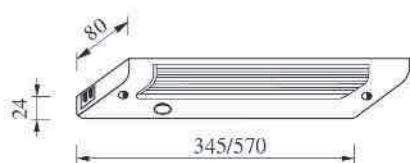

Tubo fluorescente incluso
8W (codice FL8W/30)



8 W • mm. 345

colore	Art.	€
bianco	0401201	43,50
nero	0401205	47,50
grigio	0401210	43,50

13 W • mm. 570

colore	Art.	€
bianco	0401501	47,50
nero	0401503	52,00
grigio	0401510	47,50

PROFILO copriluce in alluminio con testate di chiusura laterali

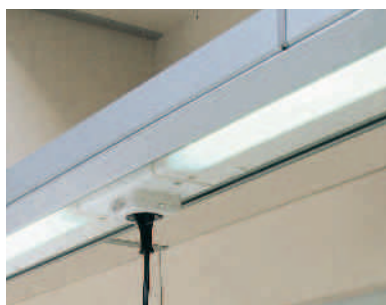

	Art.	€
Profilo 2000 mm	6814012B	68,00
Testata dx	6838612	10,00
Testata sx	6838712	10,00

PRESE modulari metalliche - schuko . Cavo 3 x 1,5 mm - 2 m - predisposte per fila continua 230V - Max 1250 W (x2)

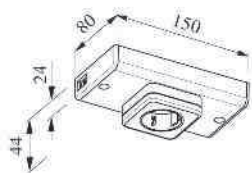

PRESA SINGOLA

colori	Art.	€
alluminio	1908612	46,00
bianco	1908601	46,00
nero	1908603	46,00

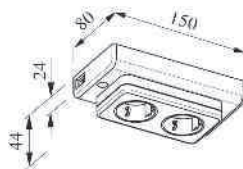

PRESA DOPPIA

colori	Art.	€
alluminio	1909112	76,00
bianco	1909101	76,00
nero	1909103	76,00

SLIDE

Lampada in alluminio, 220-240V. Predisposta per fila continua con fluorescenza T2, rotante.

NEW

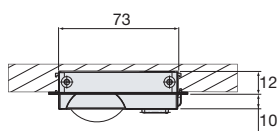
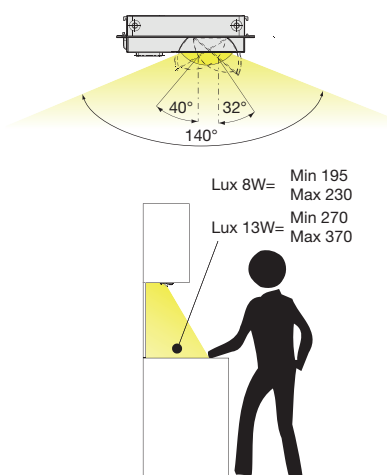

Foro incasso
75 x 377/579

SEMINCASSO

W	L= mm	Art.	€
8	384	152000312..	111,00
13	587	152000412..	117,00

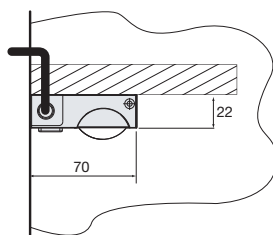
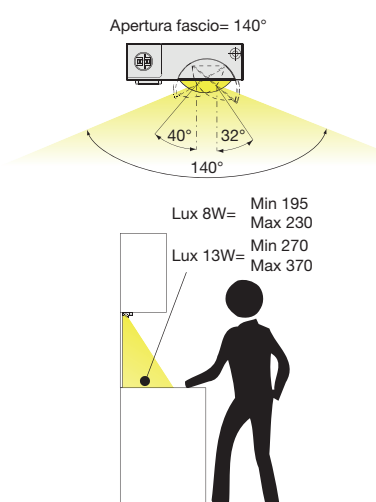
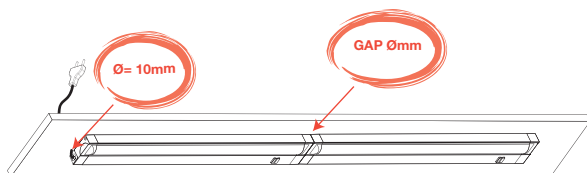

SPORGENTE

W	L= mm	Art.	€
8	383	152000112..	114,50
13	586	152000212..	121,00

RETTANGOLO

Spot LED sporgente in alluminio con led "high flat power" e controllo di temperatura integrato - W 1,8 - 12V - °K 6500

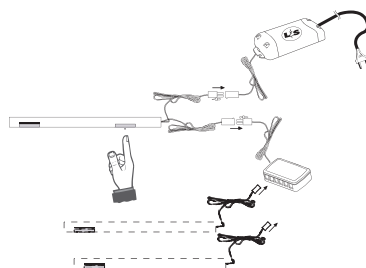
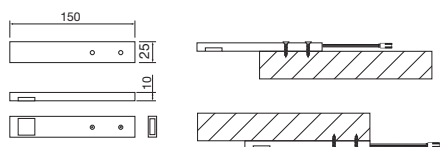

RETTANGOLO

Singolo - 128016612 | € 68,00

SLT ALIMENTATORE CABLATO CON DISTRIBUTORE A 6 VIE

Max 15 W - 125005601 | € 33,00

Max 30 W - 125008501 | € 51,00

KIT RETTANGOLO CON TOUCH COMPLETO DI ALIMENTATORE E DISTRIBUTORE

Kit 2 - 128023012 | € 218,00

Kit 3 - 128023112 | € 286,00

TRACK RETTANGOLO

Barra in alluminio con LED "high flat power" e controllo della temperatura integrato - 12V - °K 6500

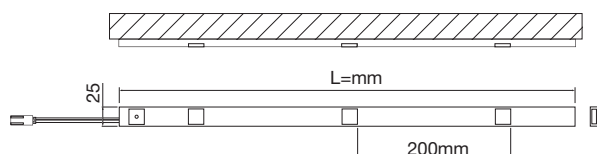

TRACK RETTANGOLO

N° LED	Watt	L= mm	Art.	€
2	3,6	450	128016812	127,00
2	3,6	500	128016412	129,00
3	5,4	600	128015812	174,00
4	7,2	800	128015912	224,00
4	7,2	900	128016012	235,00
5	9,0	1000	128016112	290,00
6	10,8	1200	128016212	337,00

TRACK RETTANGOLO TOUCH

Art.	€
128016512	175,00
128015012	220,00
128015112	269,00
128015212	281,00
128015712	328,00
128015312	383,00



SLT ALIMENTATORE CABLATO CON DISTRIBUTORE A 6 VIE

Max 15 W - 125005601 | € 33,00
 Max 30 W - 125008501 | € 51,00

BALI

Lampada in alluminio sporgente con illuminazione a LED HE. Ideale per applicazioni interne ai mobili; non servono lavorazioni di fresatura per l'installazione.

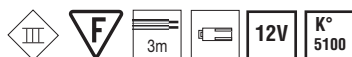
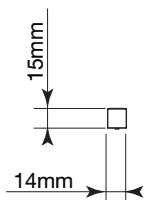

n° LED	W	L=mm	Art.	€
24	1,65	450	159000112..	57,50
48	3,3	600	159000212..	85,00
72	5,0	900	159000312..	116,00
96	6,6	1200	159000412..	146,00

CON MICROTUCH

n° LED	W	L=mm	Art.	€
24	1,65	450	159000512..	80,00
36	2,4	600	159000612..	107,50
72	5,0	900	159000712..	139,00
96	6,6	1200	159000812..	168,50

Necessita sempre di trasformatore da 30 W 125008501



SLT ALIMENTATORE CABLATO CON DISTRIBUTORE A 6 VIE

Max 15 W - 125005601	€ 33,00
Max 30 W - 125008501	€ 51,00

MANILA

Lampada in alluminio da incasso con illuminazione a LED HE.
Ideale per mensole ed elementi sottopensile.

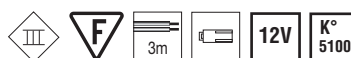
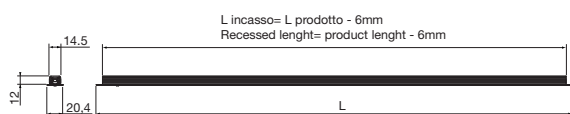
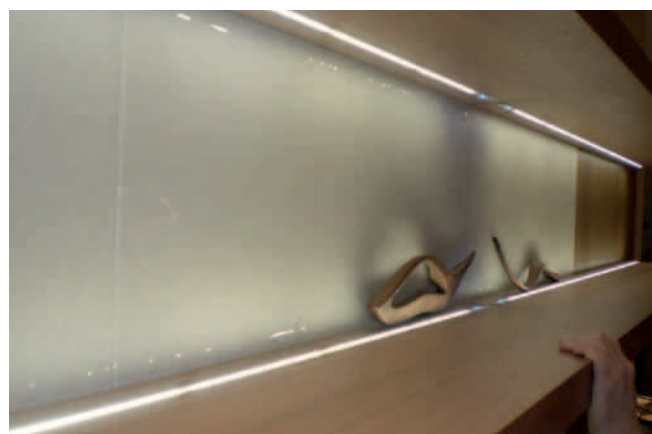
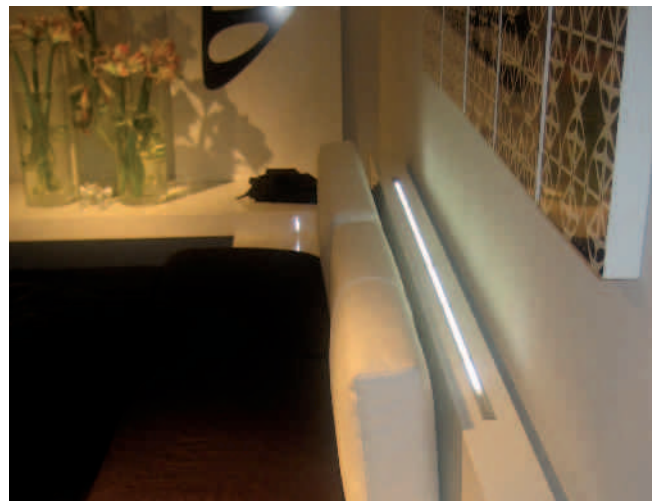
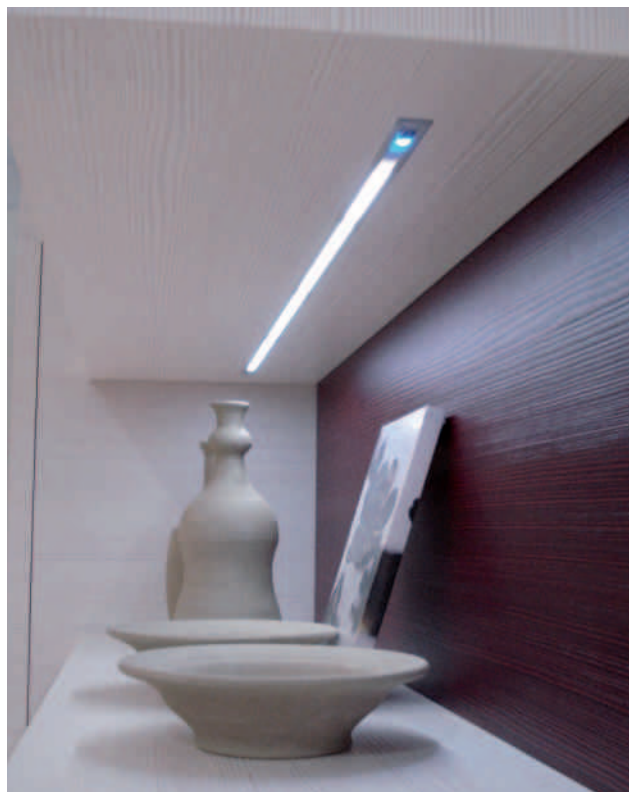

n° LED	W	L=mm	Art.	€
36	2,4	500	157000112..	67,00
60	4,1	760	157000212..	97,00
84	5,8	1000	157000312..	127,00

CON MICROTOUCH

n° LED	W	L=mm	Art.	€
538	36	2,4	500	157000412.. € 89,50
539	60	4,1	760	157000512.. € 119,50
540	84	5,8	1000	157000612.. € 151,50

Necessita sempre di trasformatore da 30 W 125008501



SLT ALIMENTATORE CABLATO CON DISTRIBUTORE A 6 VIE

078	Max 15 W - 125005601	€ 33,00
478	Max 30 W - 125008501	€ 51,00

TRACK RETTANGOLO EVOLUTION

Barra in alluminio con LED, a completamento della nuova gamma rettangolo evolution.

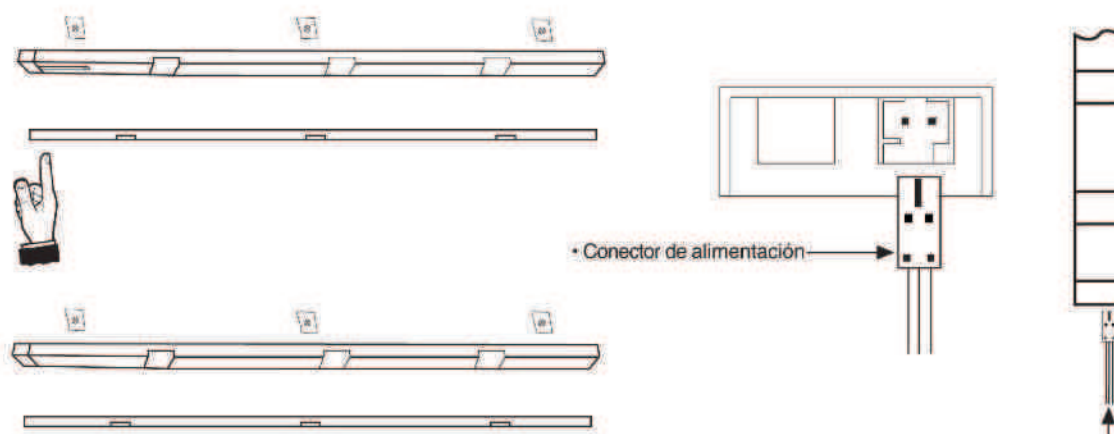

Versione	N° LED	°K	W	mA	lux (*)	L=mm	Art.	€
No Touch	2		2,4	350		450	16100031200	89,00
	2		2,4			500	16100041200	99,00
	3		3,6			600	16100051200	129,00
	4		4,8			800	16100061200	178,00
	4		4,8			900	16100071200	188,00
	5		6,0			1000	16100081200	228,00
Touch	6		7,2	1200	16100091200	272,00		
	2		2,4	350		500	16100101200	117,00
	2		3,6			600	16100111200	146,00
	3		4,8			800	16100121200	196,00
	4		4,8			900	16100131200	206,00
	5		6,0			1000	16100141200	245,00
6		7,2	1200			16100151200	290,00	
Connection cord						1000	12804130100	3,00
						2000	12804140100	3,50
Soft link						500	12804070100	3,00
						1000	12804080100	3,00
						2000	12804090100	3,50

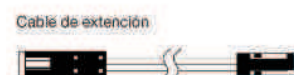

(*) illuminazione a 50 cm

FLY LIGHT

Innovativo profilo plastico con barre LED integrate. Questo elemento è installabile direttamente su vetri di spessore variabile da 6 a 10 mm. Un'applicazione semplice per un effetto luminoso molto scenografico.



Versione	N° LED	°K	W	VDC	lux (*)	L=mm	Art.	€
	10	---	0,7	---	---	413	16900166500	44,50
	20	---	1,4	12	---	563	16900136500	63,00
	30	---	2,1	---	---	863	16900146500	87,00
	40	---	2,8	12	---	1163	16900156500	110,00



DELTA

Faretto alogeno 12 V realizzato in alluminio completo di cavo di alimentazione con connettore MPK.

KIT DELTA

Kit composto da 2/3 faretto alogeni "Delta" con trasformatore elettronico completo di cablaggio e sistema di connessione "Pratika", con un interruttore ogni kit.

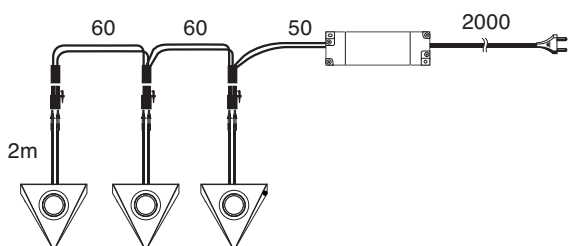
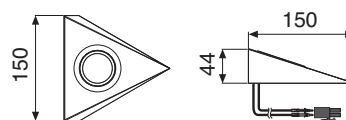

	W	Art.	Colore	€
Singolo	20	118000512..	alluminio anodizzato	16,50
Singolo	20	118000591..	acciaio spazzolato	16,50
Kit 2	2x20	124005412..	alluminio anodizzato	55,50
Kit 2	2x20	124005491..	acciaio spazzolato	55,50
Kit 3	3x20	124005512..	alluminio anodizzato	70,00
Kit 3	3x20	124005591..	acciaio spazzolato	70,00

PRESA SCHUKO

colori	Art.	€
alluminio anodizzato	121000812..	24,00
acciaio spazzolato	121000891..	24,00

INTERRUTTORE

Art.	€
121000912..	21,50
121000991	21,50

WILLY

Faretto alogeno dicroico orientabile max 50W - 12V, att. G 5,3 - in metallo e plastica con connettore per connessione rapida. Colore cromo

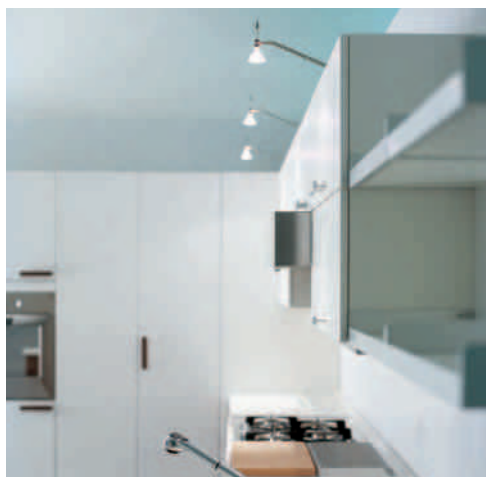

KIT WILLY

Kit faretto alogeni dicroici orientabili max 20W 12V att. G5,3, trasformatore elettronico 230/12V e cablaggi per connessioni rapide. Lampade alogene dicroiche 20W incluse.

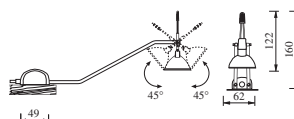

	Art.	€
Singolo	N1614009	29,00
Kit 2	9925309	84,00
Kit 3	9925509	114,00

ACCESSORI

colore nichel opaco	Art.	€
testina decorativa	A 6905684/S	3,00
testina decorativa	B 6905784/S	6,00
cavetto ponte 150 mm	C 7803403	1,50

EASY

Faretto alogeno in materiale termoplastico con interruttore • 20W

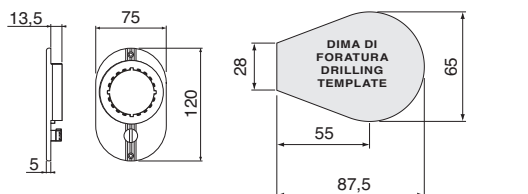

colore	Art.	€
Alluminio	N1631512	15,00



URANIO

Lampada alogena in materiale termoplastico con trasformatore 230/12V. Con interruttore rotativo a fine corsa.

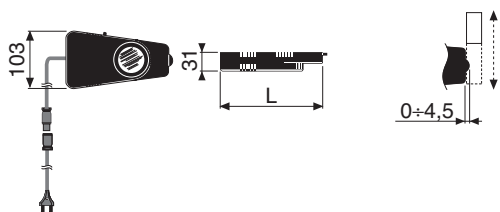

colore	Art.	€
Grigio	1645010	55,00



VANADIO

Lampada sporgente 230V att. E14 max 25W completa di riflettore in alluminio, interruttore finecorsa a rotella ed interruttore supplementare a bilanciere (l'interruttore ha il solo scopo di lasciare la lampada sempre accesa).

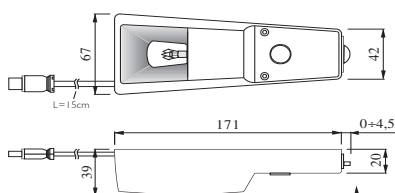

colore	Art.	€
Grigio	M1521010LP	27,00

Fine corsa a rotella
0 ÷ 4,5

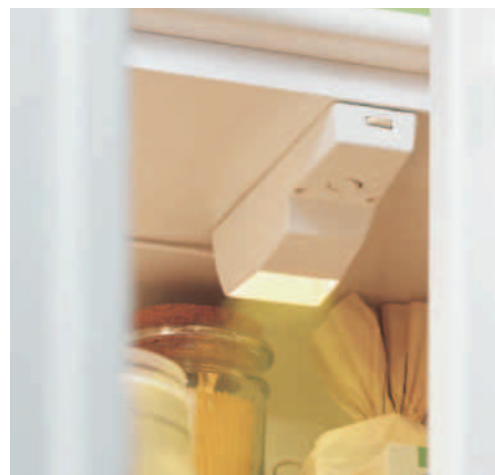

MINI MOBILIGHT SENSOR

Lampada fluorescente in alluminio completa di interruttore - SENSOR che reagisce alla presenza di persone, accendendo automaticamente la lampada.

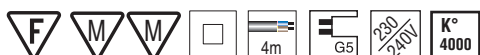
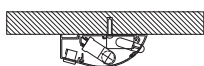
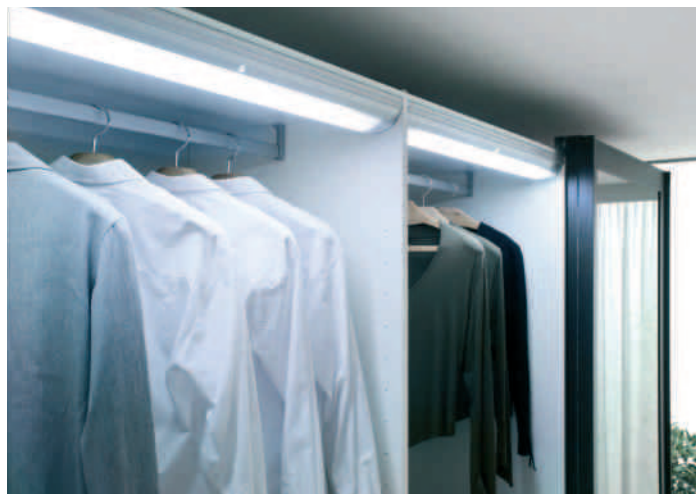
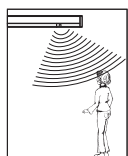
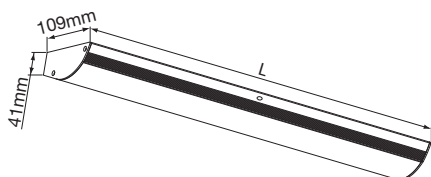

W	L=mm	Art.	€
6	300	144000112..	131,00
8	530	144000212..	135,00
13	680	144000312..	151,00
13	850	144000412..	158,00
21	1100	144000512..	171,00

TITANIO

Lampada alogena rotante 20W 12V att. G4, completa di trasformatore 230/12V.

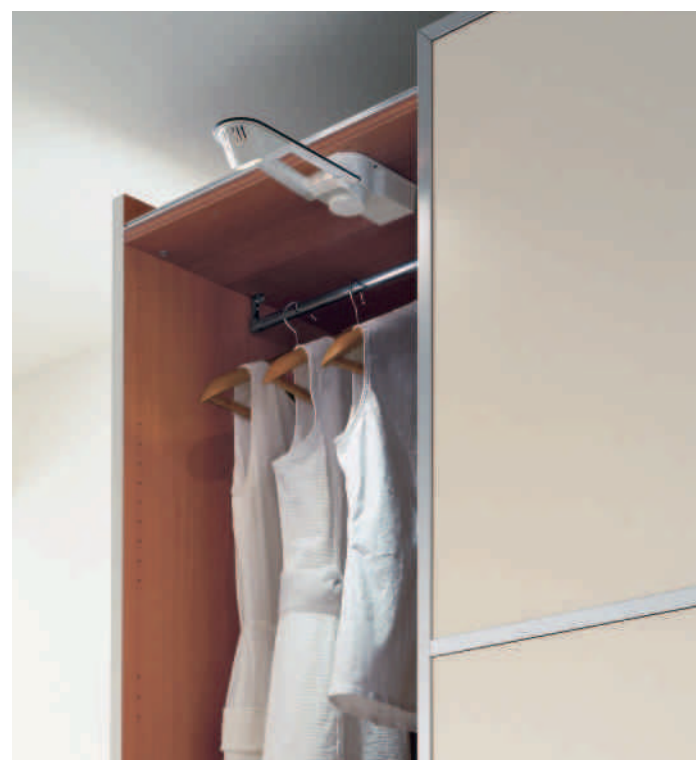
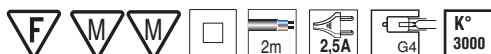
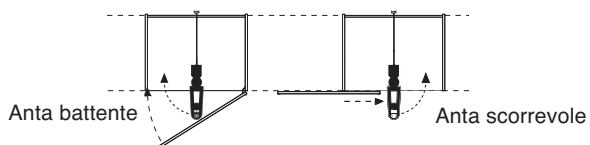

colore	Art.	€
Grigio	1668010	95,00

FREE LED HE

Lampada appendiabiti in alluminio con illuminazione a LED HE ed interruttore - SENSOR che reagisce alla presenza di persone, accendendo automaticamente la lampada.

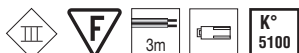
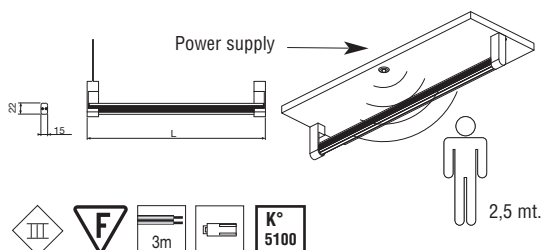

LAMPADA

N°LED	W	V	L= mm	Art.	€
36	2,4		540	156000112..	71,00
60	3,3	12	750	156000212..	100,00
72	5		870	156000312..	116,00
84	5,8		1050	156000412..	133,00

POWER SUPPLY - TRASFORMATORE CON SENSORE

W	V	L= mm	Art.	€
15	230/240	---	126015901..	105,00
30		---	126016001..	127,00

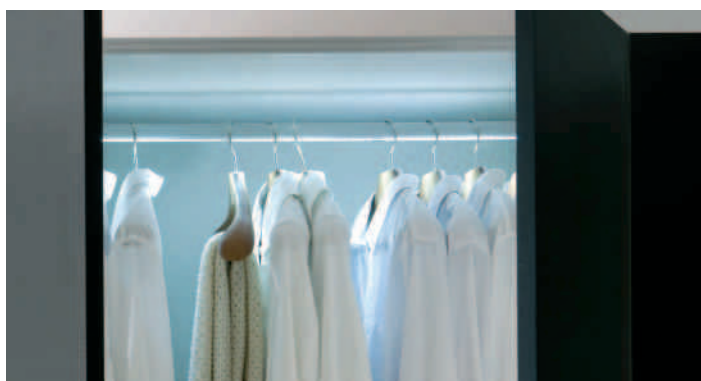

FREE SENSOR

Lampada in alluminio con illuminazione fluorescente elettronica - 230/240V

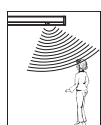

max 6 mt.

• Con interruttore- SENSOR che reagisce alla presenza di persone, accendendo automaticamente la lampada.



Supporto di metallo

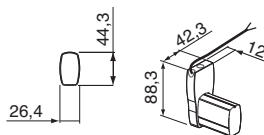

W	L= mm	Art.	€
8	560	230560M/8W-S.01	142,00
13	860	230860M/13W-S.1	163,00
21	1080	231080M/21W-S.1	189,00



MONOVOLUME SENSOR

Lampada in alluminio da incasso con illuminazione fluorescente elettronica con interruttore-SENSOR che reagisce alla presenza di persone, accendendo automaticamente la lampada.

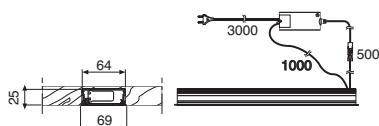
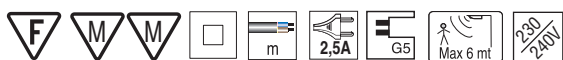

W	L= mm	Art.	€
8	370	129002612..	167,00
13	610	129002712..	184,00
21	920	129002912..	211,00
28	1230	129003012..	243,00

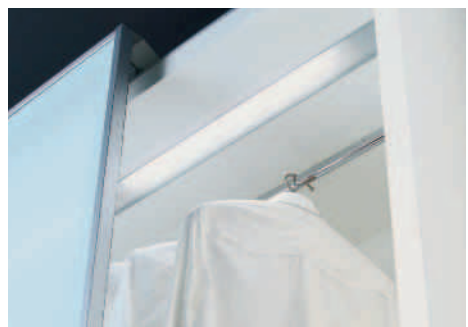

ARLEY

Lampada fluorescente omnidirezionale con luce oscurabile. In alluminio.

con BRACCIO FLESSIBILE E FISSAGGIO SU TESTIERA

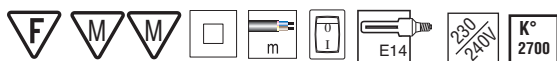
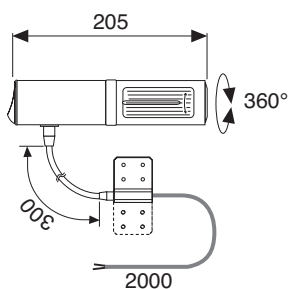

	W	Art.	€
dx	7	111000312..	85,50
sx	7	111000412..	85,50

CONO LED

Lampada in alluminio e braccio flessibile con illuminazione ad 1 LED completa di alimentatore.

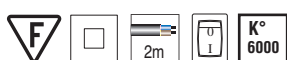
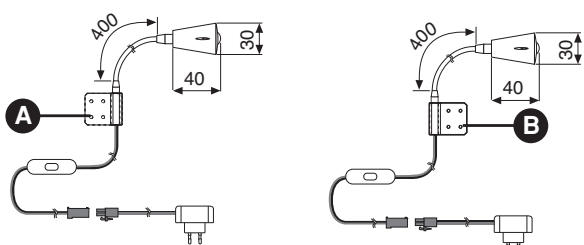

Colore	V	W	Art.	€
A Grigio metallizzato - dx	12	1,2	128001165..	119,00
B Grigio metallizzato - sx	12	1,2	128001265..	119,00

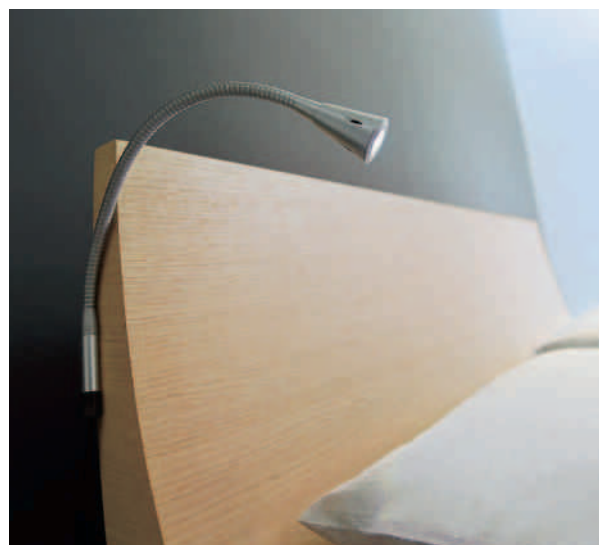

MINIFLAT LED

Lampada in alluminio e braccio flessibile con illuminazione ad 1 LED completa di alimentatore.

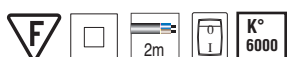
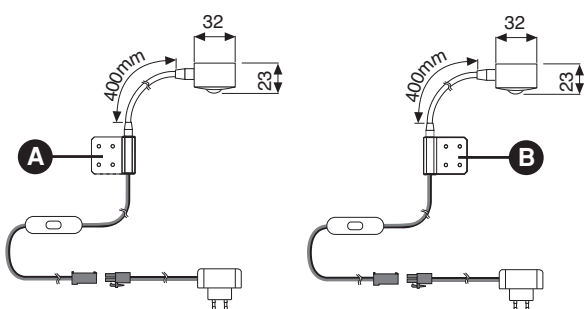

Colore	V	W	Art.	€
A Grigio metallizzato - dx	12	1,2	128000765..	117,00
B Grigio metallizzato - sx	12	1,2	128000865..	117,00

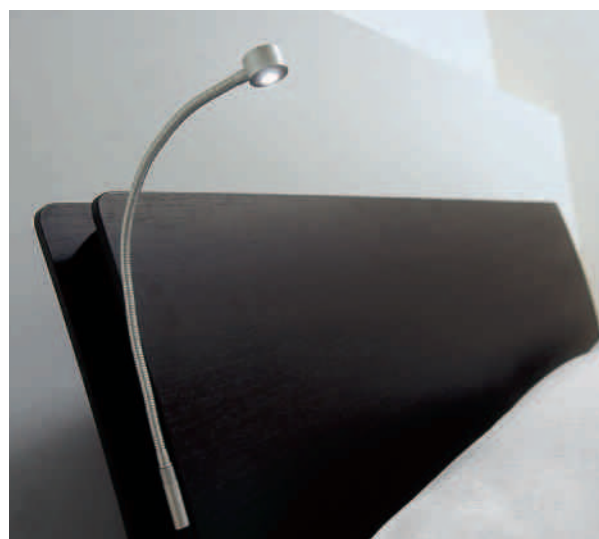

FLIP - A

Faretto alogeno in metallo verniciato e vetro decorativo, con braccio flessibile. Predisposto per il fissaggio a pannello.

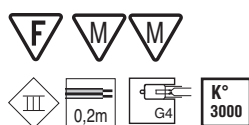
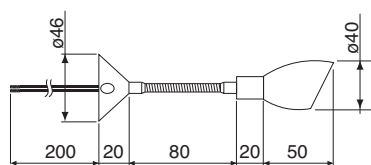

Colore	V	W	Art.	€
Grigio metallizzato	12	20	133000465..	47,00



KUBIK

Faretto alogeno 20W 12V predisposto per connessione rapida.

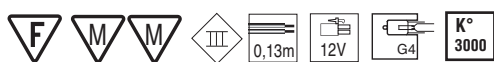
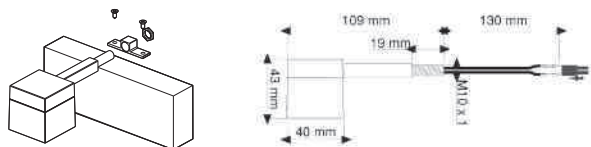

colore	Art.	€
Grigio metallizzato	1336565-25	30,00

DEMO & NEMO

Faretto alogeno dicroico da incasso in metallo IP55 max 50W - 12V

DEMO

NEMO

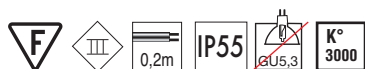
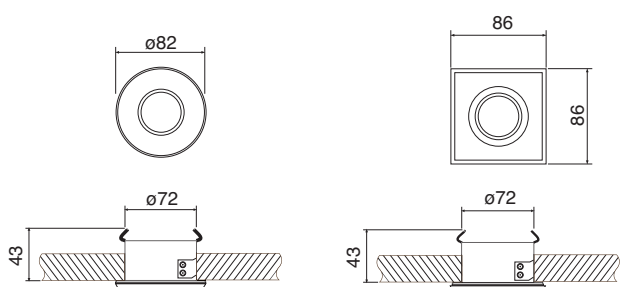

DEMO	Colori	Art.	€
	Bianco	1180012-01	18,00
	Cromo	1180012-09	19,00
	Grigio met.	1180012-65	18,00

NEMO	Colori	Art.	€
	Bianco	1180013-01	18,00
	Cromo	1180013-09	19,00
	Grigio met.	1180013-65	18,00

LIGHT LINE

Faretto LED di potenza in metallo orientabile per applicazione a pannello, un'altra espressione del design di L&S.

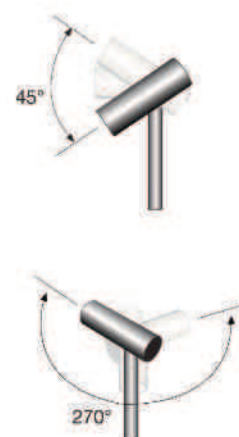
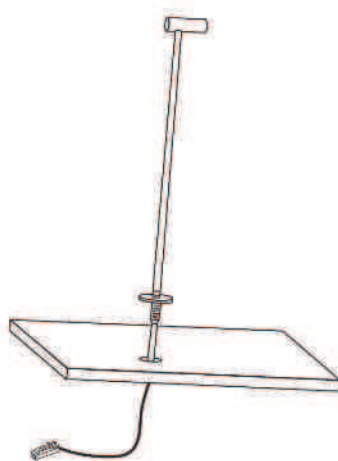

Versione	N° LED	°K	W	mA	lux (*)	L=mm	Art.	€
	1	5000	1,2	350		----	16800010300	72,00
		5000					16800016500	72,00

LIGHT POINT

Faretto LED di potenza in metallo ad incasso orientabile, i vantaggi della tecnologia a LED con la purezza del design L&S.

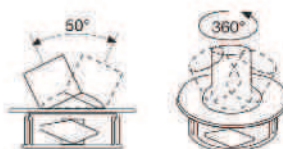
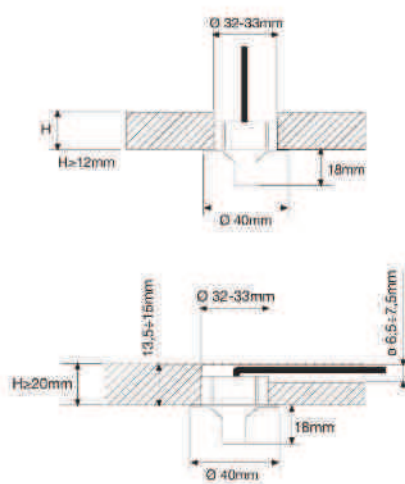

Versione	N° LED	°K	W	mA	lux (*)	⊙	Ø mm	Art.	€
	1	5000						16800020300	65,00
		3200	1,2	350		61	65,5	16800026500	65,00
								16800040300	65,00
								16800046500	65,00

BOMBAY A

Faretto in alluminio con illuminazione a LED, il ritorno alle rotondità e la tecnologia più moderna in un concetto di luce nuovo. Un prodotto che rappresenta una proposta di design con un valore costo-prestazione vincente nel mercato.

Versione con LED da 1,2W

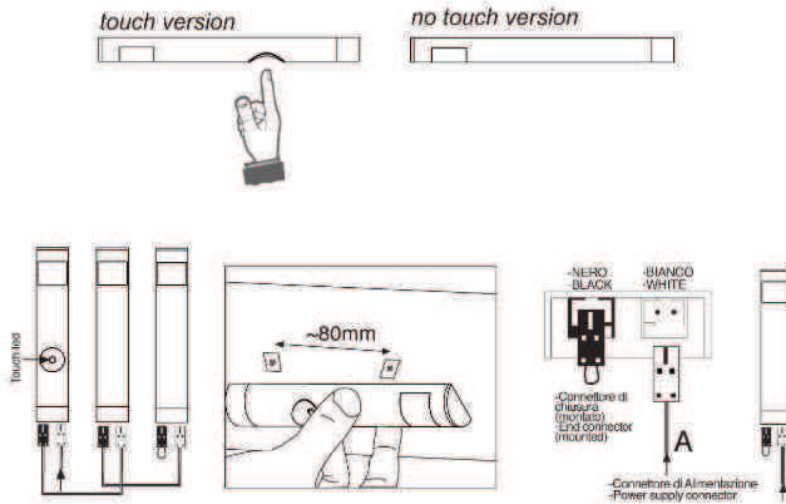

Versione	N° LED	°K	W	mA	lux (*)	L=mm	Art.	€
No touch	1	6000	1,2	350	50	150	16500011200	45,00
Touch	1	6000	1,2	350	50	150	16500041200	80,00

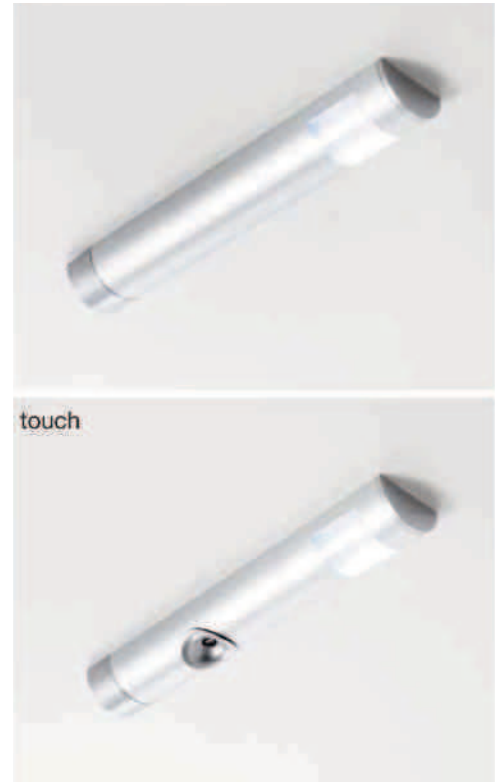

BOMBAY C

Versione con LED di potenza da 3W

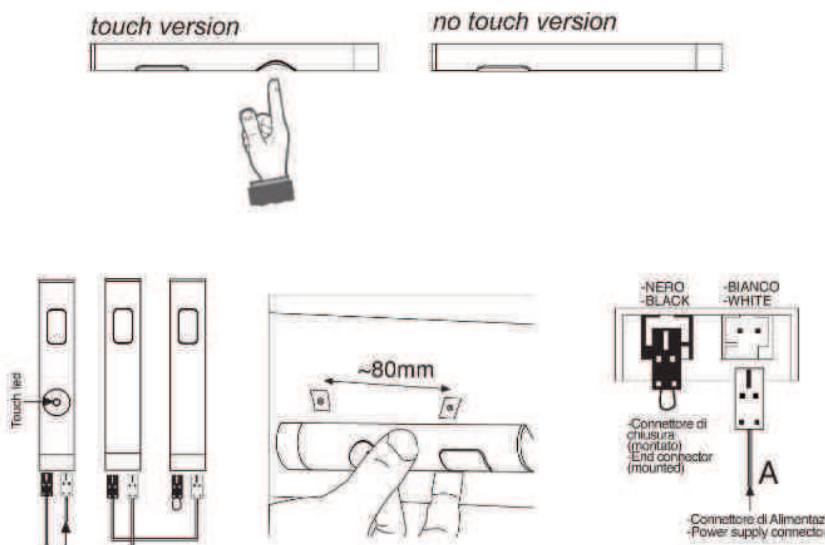

Versione	N° LED	°K	W	mA	lux (*)	L=mm	Art.	€
No touch	1	5000	3	350	150	150	16500031200	98,50
Touch	1	5000	3	350	150	150	16500061200	136,00

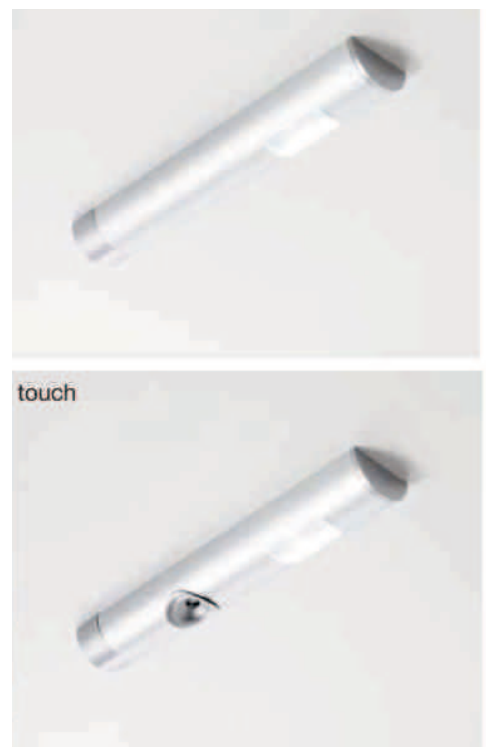

(*) illuminazione a 50 cm

APOLLO I

Faretto alogeno dicroico da incasso in metallo max 50W, 12V.

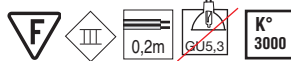
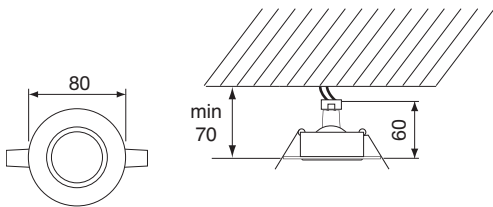

Colore	⌀=mm	ø=mm	Art.	€
acciaio inox	60	80	118014590..	21,00

APOLLO II

Faretto alogeno dicroico da incasso in metallo max 50W, 12V.

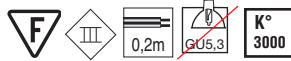
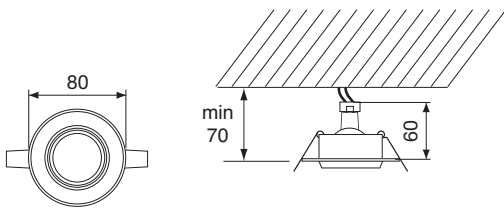

Colore	⌀=mm	ø=mm	Art.	€
acciaio inox	60	80	118014690..	21,00

APOLLO III

Faretto alogeno dicroico orientabile da incasso in metallo max 50W, 12V.

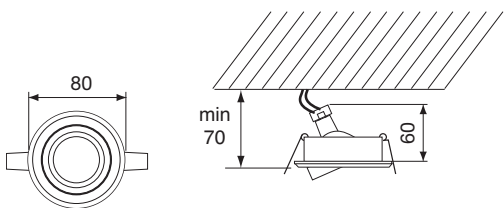

Colore	⌀=mm	ø=mm	Art.	€
acciaio inox	60	80	118014790..	26,00

LOIRA ORIENTABILE

Faretto alogeno da incasso in metallo per lampada dicroica 50W, 12V

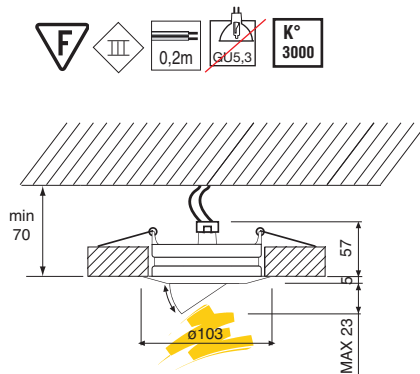

Foro incasso Ø 88 mm

Colori	Art.	€
bianco	IT6000701/S	17,00
nero	IT6000708/S	23,00
oro	IT6000709/S	19,00
acciaio inox	IT6000790/S	19,00

SENNA

Faretto alogeno da incasso in metallo per lampada dicroica 50W, 12V

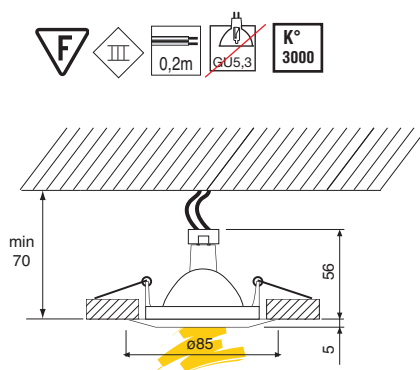

Foro incasso Ø 70 mm

Colori	Art.	€
bianco	IT6000801/S	9,00
nero	IT6000803/S	9,00
oro	IT6000808/S	12,00
cromo	IT6000809/S	11,00
acciaio inox	IT6000890/S	11,00

QUADRO

Faretto alogeno da incasso in metallo con lampada dicroica 50W, 220-230V.

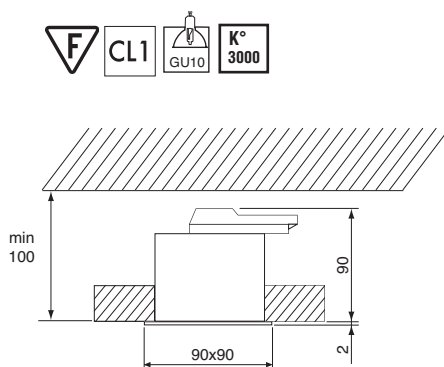

Foro incasso 82 x 68 mm

Colori	Art.	€
grigio metall.	IT1610165/3LP	35,00

TURNO ORIENTABILE

Faretto alogeno dicroico da incasso in metallo max 50W 220/230V

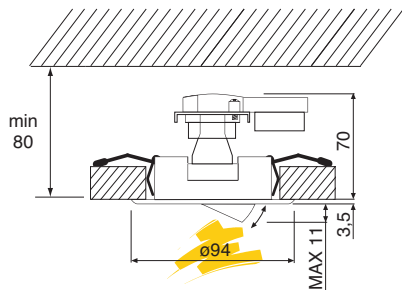

Foro incasso Ø 82 mm

Colori	Art.	€
bianco	IT1696801/S	14,00
nero	IT1696803/S	14,00
oro	IT1696808/S	15,00
cromo	IT1696809/S	15,00



TURNO FISSO

Faretto alogeno dicroico da incasso in metallo max 50W 220/230V

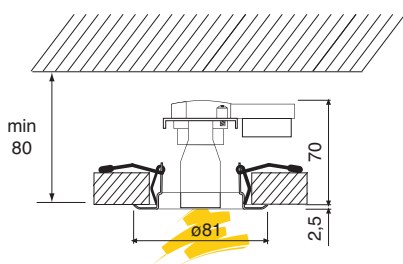

Foro incasso Ø 70 mm

Colori	Art.	€
bianco	IT1696701/S	11,00
nero	IT1696703/S	11,00
oro	IT1696708/S	12,00
cromo	IT1696709/S	12,00



NILO 2X26W

Faro ad incasso in metallo, con vetro satinato e riflettore in alluminio, predisposto per lampade fluorescenti "PL" 230V 50Hz e completo di alimentatore elettronico.

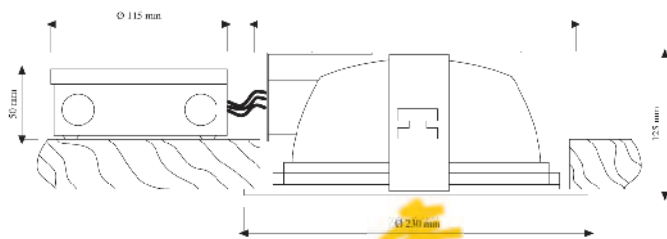

Foro incasso Ø 210 mm



Lampada fluorescente inclusa.
DULUX-D OSRAM 18 W (FPL18W/21)
DULUX-D OSRAM 26 W (FPL26W/21)

Colore	Ø=mm	Art.	€
bianco	230	118002701..	124,00
acciaio spazz.	230	118002791..	132,00

SUNNY HE. in DA INCASSO

Spot ad incasso con LED ad alta efficienza in materiale termoplastico e ghiera in metallo - W 1,25 - 12V



SUNNY HE • in TT (tondo - tondo)

n° LED	Gradi °K	colore	Art.	€
18	3200	bianco	128024601	30,00
18	3200	cromo	128024609	30,00
18	3200	metallizzato	128024665	30,00
18	3200	inox spazzolato	128024691	30,00
18	5100	bianco	128024701	26,00
18	5100	cromo	128024709	30,00
18	5100	metallizzato	128024765	26,00
18	5100	inox spazzolato	128024791	30,00

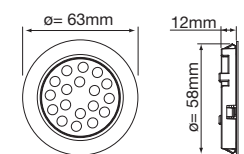

foro incasso Ø 58 mm



SUNNY HE • in QT (quadro - tondo)

n° LED	Gradi °K	colore	Art.	€
18	3200	bianco	128024801	30,00
18	3200	cromo	128024809	30,00
18	3200	metallizzato	128024865	30,00
18	3200	inox spazzolato	128024891	30,00
18	5100	bianco	128024901	26,00
18	5100	cromo	128024909	30,00
18	5100	metallizzato	128024965	26,00
18	5100	inox spazzolato	128024991	30,00

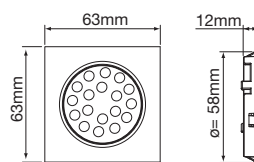

SUNNY HE • in QQ (quadro - quadro)

n° LED	Gradi °K	colore	Art.	€
16	3200	bianco	128025001	26,00
16	3200	cromo	128025009	26,00
16	3200	metallizzato	128025065	26,00
16	3200	inox spazzolato	128025091	30,00
16	5100	bianco	128025101	26,00
16	5100	cromo	128025109	26,00
16	5100	metallizzato	128025165	26,00
16	5100	inox spazzolato	128025191	30,00

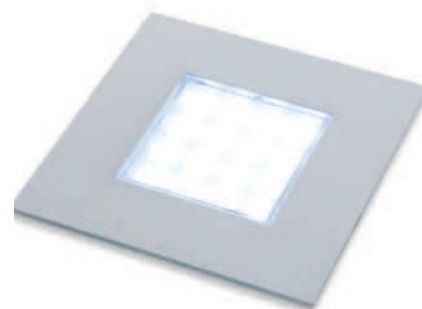
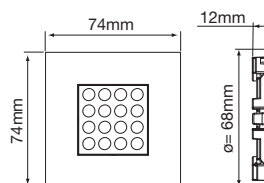

SLT | ALIMENTATORE CABLATO CON DISTRIBUTORE A 6 VIE

Max 15 W - 125005601	€ 33,00
Max 30 W - 125008501	€ 51,00

SUNNY HE SPORGENTE

Spot sporgente ad alta efficienza in materiale termoplastico con illuminazione a **18 LED** - W 1,25 - 12V

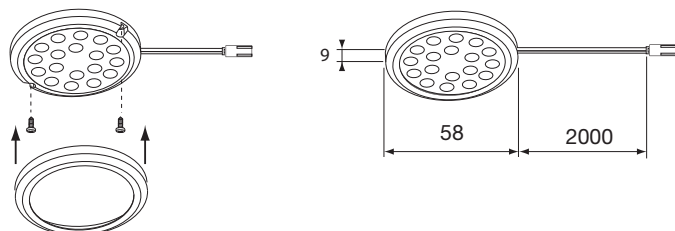

Gradi °K	colore	Art.	€
3200	cromo	128022309	28,00
3200	metallizzato	128022365	28,00
3200	inox spazzolato	128022391	28,00
5100	cromo	128022409	28,00
5100	metallizzato	128022465	28,00
5100	inox spazzolato	128022491	28,00

SUNNY SQUARE HE SPORGENTE

Spot sporgente ad alta efficienza in materiale termoplastico con illuminazione a **16 LED** - W 1,25 - 12V

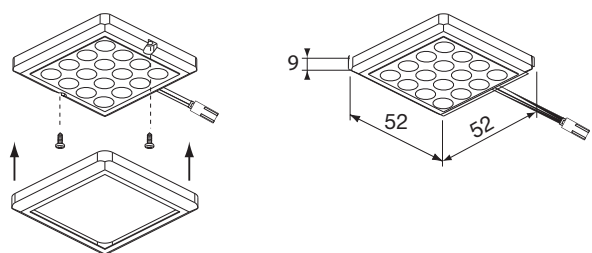

Gradi °K	colore	Art.	€
3200	cromo	128022509	28,00
3200	metallizzato	128022565	28,00
3200	inox spazzolato	128022591	28,00
5100	cromo	128022609	28,00
5100	metallizzato	128022665	28,00
5100	inox spazzolato	128022691	28,00



SLT ALIMENTATORE CABLATO CON DISTRIBUTORE A 6 VIE

Max 15 W - **125005601** | € **33,00**

Max 30 W - **125008501** | € **51,00**

TONGA

Spot con LED di potenza - 1,2 W - 12V - **Semincasso** in plastica trasparente e ghiera colorata



Gradi °K	colore	Art.	€
6500	bianco	128031801..	27,00
6500	cromo	128031809..	27,00
6500	grigio metallizzato	128031865..	27,00
3200	bianco	128032601..	27,00
3200	cromo	128032609..	27,00
3200	grigio metallizzato	128032665...	27,00

Su ordinazione i colori:
02 • Rosso - 04 • Giallo - 16 • Blu - 80 • Colore inox

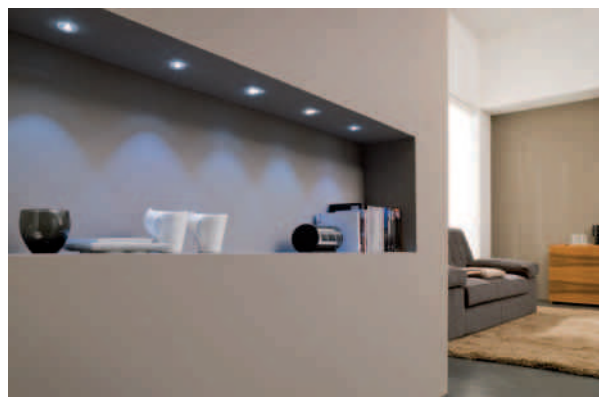
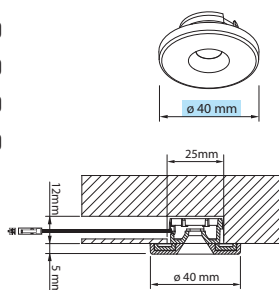

FIJI

Spot con LED di potenza - 1,2 W - 12V - **Semincasso** in plastica trasparente e ghiera colorata



Gradi °K	colore	Art.	€
6500	bianco	128031901..	27,00
6500	cromo	128031909..	27,00
6500	grigio metallizzato	128031965..	27,00
3200	bianco	128032701..	27,00
3200	cromo	128032709..	27,00
3200	grigio metallizzato	128032765...	27,00

Su ordinazione i colori:
02 • Rosso - 04 • Giallo - 16 • Blu - 80 • Colore inox

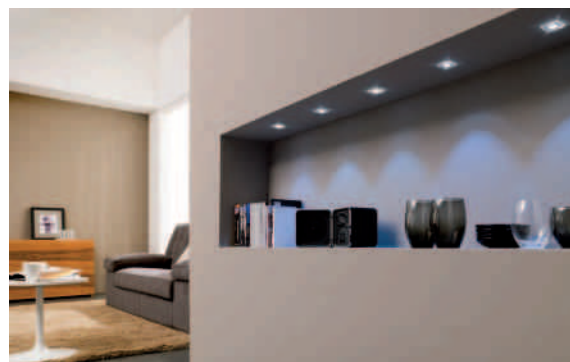
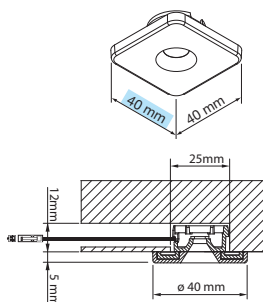

SAMOA

Spot con LED di potenza - 1,2 W - 12V - **Incasso** in plastica trasparente e ghiera colorata



Gradi °K	colore	Art.	€
6500	bianco	128032001..	23,00
6500	cromo	128032009..	23,00
6500	grigio metallizzato	128032065..	23,00
3200	bianco	128032801..	23,00
3200	cromo	128032809..	23,00
3200	grigio metallizzato	128032865...	23,00

Su ordinazione i colori:
02 • Rosso - 04 • Giallo - 16 • Blu - 80 • Colore inox

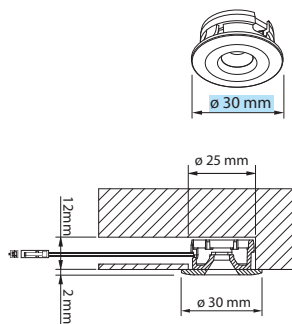

ALIMENTATORE CABLATO CON DISTRIBUTORE

406	6 uscite - Max 7,2 W - 12503010100	€ 31,00
	9 uscite - Max 12 W - 12503020100	€ 49,00

MATRIX

Spot sporgente ad alta efficienza in materiale termoplastico con illuminazione a 25 LED - W 2 - 24V .
Il faretto è completo di n° 2 ghiera di colore grigio metallizzato e acciaio inox.

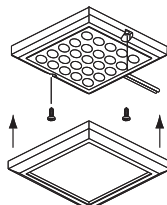
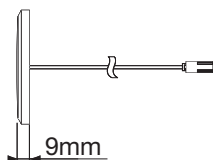
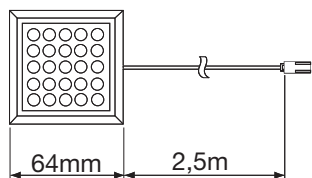

Gradi °K	Art.	€
3200	128025200	34,00
5100	128025300	32,00

12501280100 Trasf. 15W con distributore 4 vie - 24 VDC **33,00**



K5

Spot LED ad incasso in alluminio con 6 LED "High power" e controllo della temperatura integrato - W 3,8 - 12V .

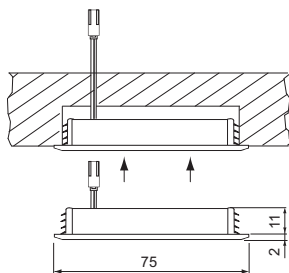

foro incasso Ø 68 mm



Gradi °K	colore	Art.	€
6500	alluminio	128014512	102,00

SLT

Alimentatore per led cablato con distributore di energia a 6 vie adatto per: K5, Sunny, Sunny Square, Rettangolo e Track Rettangolo

ALIMENTATORE CABLATO CON DISTRIBUTORE A 6 VIE

Max 15 W - 125005601	€ 33,00
Max 30 W - 125008501	€ 51,00



MICRON - P

FARETTO SINGOLO

Faretto da incasso in metallo 20W 12V, att. G4 e vetro di protezione sabbiato.

KIT 2/3 FARETTI

Kit composto da 2/3 faretti alogeni "Micron-P" con trasformatore elettronico "Mignon 20-60W" 230/12V completo di cablaggio e sistema di connessione "Mini-Pratika".

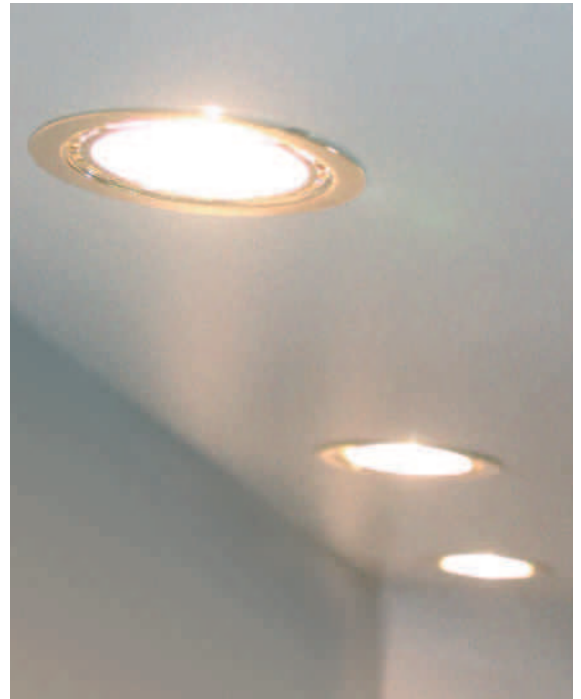
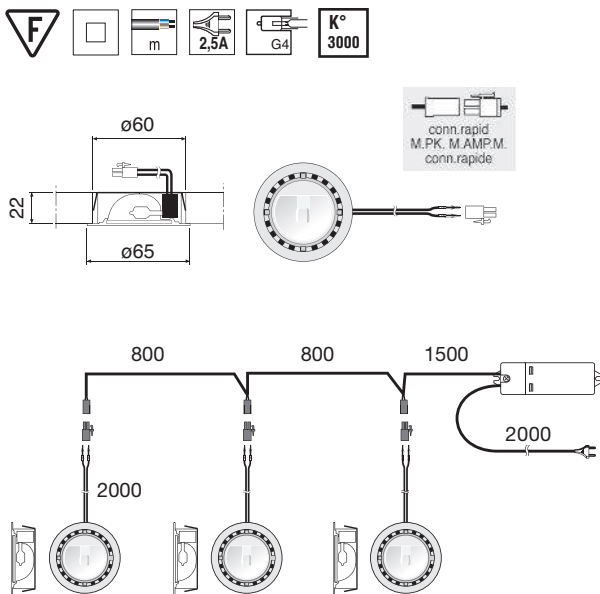

Colore	SINGOLO	Art.	€	KIT 2	W	Art.	€	KIT 3	W	Art.	€
Bianco		M1655301	6,50		2x20	124003601..	46,00		3x20	124003701..	53,00
Nero		M1655303	6,50		2x20	124003603..	46,00		3x20	124003703..	53,00
Oro		M1655308	7,50		2x20	124003608..	48,00		3x20	124003708..	55,00
Cromo		M1655309	6,50		2x20	124003609..	46,00		3x20	124003709..	53,00
Alluminio anodizzato		M1655312	6,50		2x20	124003612..	46,00		3x20	124003712..	53,00
Nichel opaco			2x20	124003685..	46,00		3x20	124003785..	53,00

DISTANZIALE in materiale autoestinguente, per tutti i faretti alogeni serie Micron.

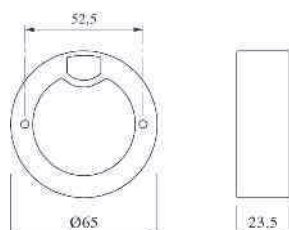

Colori	Art.	€
bianco	6617701	4,00
nero	6617703	4,00
oro	6617708	5,00
cromo	6617709	5,00

Faretti da incasso 10/ 20W in materiale termoresistente con anello in metallo e vetro di protezione sabbiato + portalampade da 50 mm.

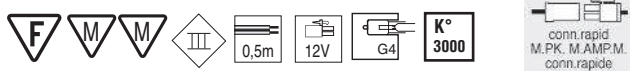

MICRON BVSC 20 W

Colori	Art.	€
bianco	1631301	11,00
nero	1631303	11,00
oro	1631308	13,00
cromo	1631309	11,00
alluminio	1631312	11,00

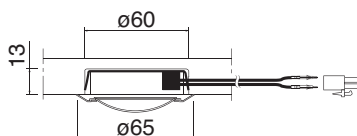

MICRON BVS 20 W

Colori	Art.	€
bianco	1631201	8,00
nero	1631203	8,00
oro	1631208	10,00
cromo	1631209	8,00
alluminio	1631212	8,00

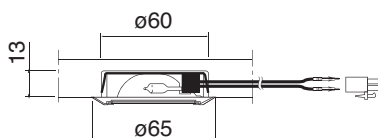

MICRON BV 10-20 W

Colori	Art. 10 W	€
bianco	M1649001	7,00
nero	M1649003	7,00
oro	M1649008	9,00
cromo	M1649009	7,00
alluminio	M1649012	7,00

Colori	Art. 20 W	€
bianco	N1612601	7,00
nero	N1612603	7,00
oro	N1612608	9,00
cromo	N1612609	7,00
alluminio	N1612612	7,00

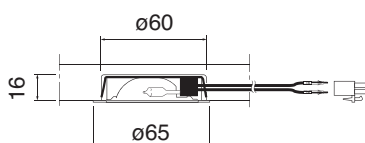

MICRON S 20 W

Colori	Art.	€
bianco	160801	10,00
nero	160803	10,00
oro	160808	10,00
cromo	160809	10,00

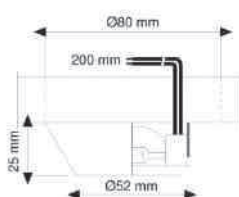

TRASFORMATORI



Elettronici con dispositivo di protezione termica e contro il cortocircuito.



MIGNON 230-240/12V

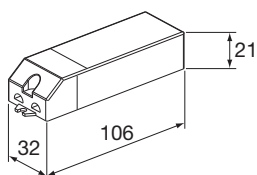

W	Art.	€
10-60	N1700101/S	18,00



FLAT 16 230-240/12V

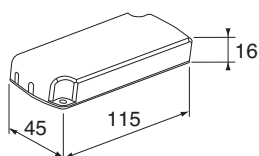

W	Art.	€
10-60	125005101..	18,00



FLAT 230-240/12V

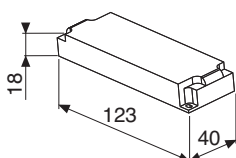

W	Art.	€
20-70	1723100/S	20,50
35-105	1723200/S	23,00



SET 210 230-240/12V

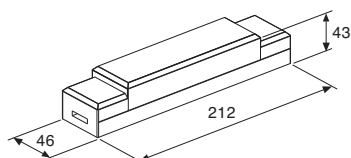

W	Art.	€
50-210	N1700303/S	42,00



FLAT + MINI - D 230-240/12V

Trasformatore cablato con distributore di energia MINI-D a 6 vie.

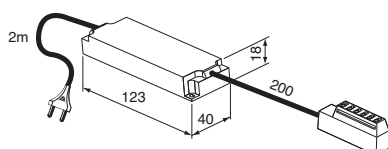

W	Art.	€
20-70	M1788201	35,00
35-105	M1788301	38,00

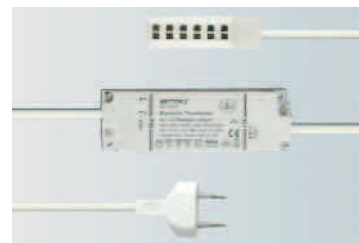

SLT 230-240/12V

Alimentatore per led cablato con distributore di energia a 6 vie adatto per: K5, Sunny, Sunny Square, Rettangolo, Track Rettangolo.



Art.	Hz	A	W	€
125005601..	50	max 1,25	max 15	33,00
125008501..	50/60	max 2,50	max 30	51,00



INFRARED DC/DC

Solo per LED - funziona a max 5 cm dall'ostacolo

W	Art.	€
Max 18	12803170100	52,00

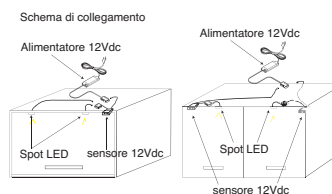

TOUCH LED SYSTEM 230 - 240 V

Sistema di comando per apparecchi luminosi con carico max 550W per un max di **tre** interruttori con l'innovativa tecnologia touch led (il comando viene attivato e disattivato al tocco del led luminoso).

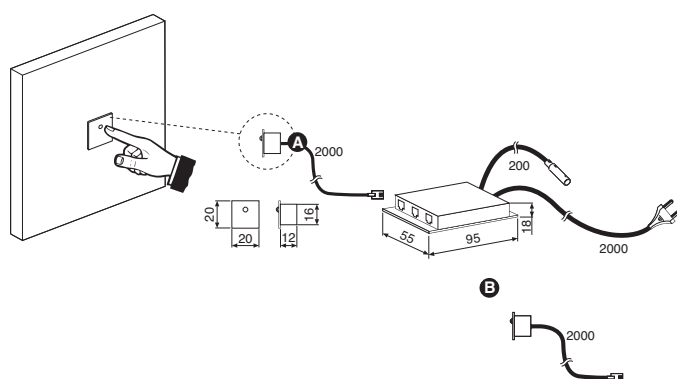

- A** Touch led system con 1 touch led
- B** Touch led - grigio metallizzato

W	Art.	€
550	124035003..	131,00
--	124005065..	45,00

KIT SENSOR 230 - 240 V

Sistema di accensione automatico per apparecchi luminosi con carico max 500W a sensore di presenza.

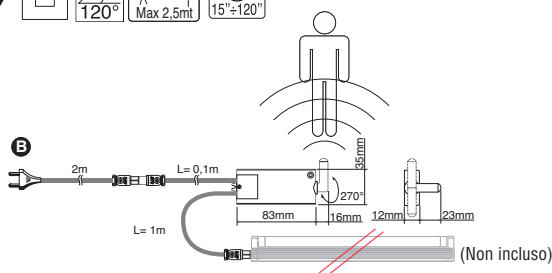
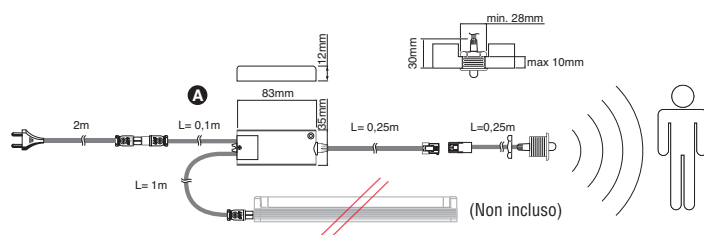

- A** Kit sensor
- B** Kit sensor

W	Art.	€
500	124035401..	70,00
500	124038201..	50,00



HIGH POWER LED SUPPLY

Alimentatore per LED cablato con distributore di energia.

Adatto per Light Line, light Point, Rettangolo, Track Rettangolo, Bombay A, Bombay C.

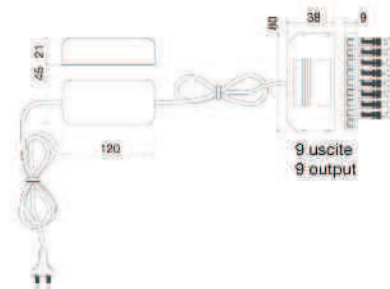
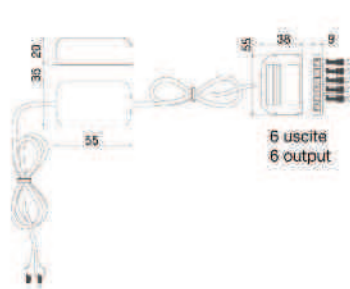
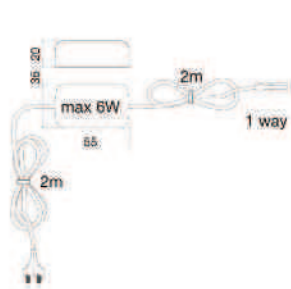

Pri		Sec			Art.	€
V	Hz	V	A	max N° LED (1 or 1,2 W)		
220-240	50/60	max 21DC	0,350	6	12503090100	26,50
		max 21DC		6	12503010100	31,00
		max 38DC		10	12503020100	49,00

SISTEMA BINARIO a bassissima tensione

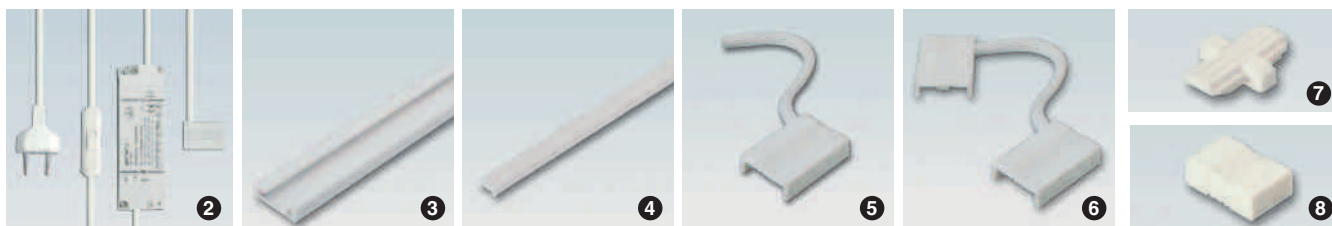
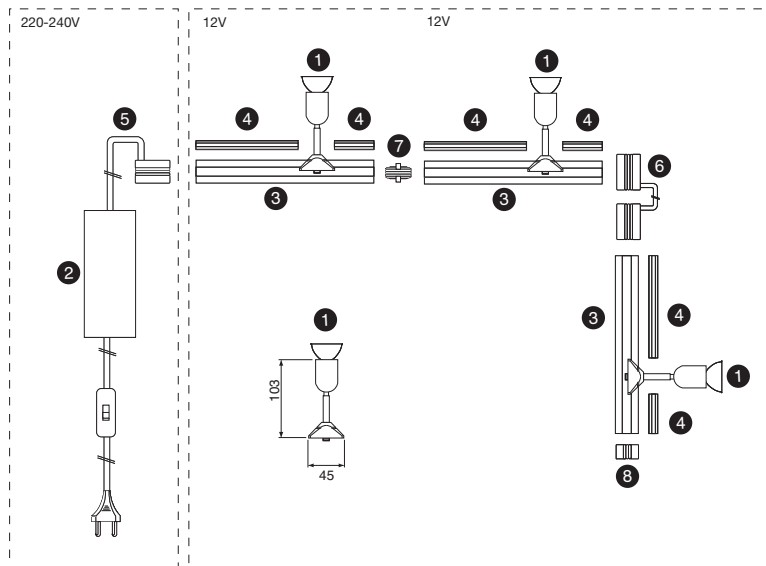

FARETTO CLICK

1 Alogeno dicroico direzionabile - 20 w - 12 v

Art.	colore	€
11700056501	grigio metallizzato	45,00

MINI TRACK SYSTEM

- 2 Trasformatore elettronico completo di connettore rapido per binario ed interruttore
- 3 Binario per bassissima tensione in plastica estrusa L= 600 mm
- 3 Binario per bassissima tensione in plastica estrusa L= 1200 mm
- 4 Profilo di copertura frontale per binario L= 1200 mm
- 5 Prolunga di connessione da trasformatore a binario L= 2000 mm
- 6 Prolunga intermedia di connessione tra binari L= 150 mm
- 6 Prolunga intermedia di connessione tra binari L= 3000 mm
- 7 Connettore ponte intermedio per binario
- 8 Tappo terminale per binario

Art.	colore	€
125002665..	grigio metallizzato	41,00
133000165..	grigio metallizzato	12,00
133000265..	grigio metallizzato	20,00
133000365..	grigio metallizzato	9,50
126004765..	grigio metallizzato	14,50
126000165..	grigio metallizzato	12,00
126000265..	grigio metallizzato	14,50
404000665..	grigio metallizzato	3,50
404000565..	grigio metallizzato	2,00

SISTEMA BINARIO



CL1



• Sistema binario per fari a pag. 46/47 •

Descrizione	L=mm	Art.	€
1a Binario	1000	141000165..	70,00
1b Binario	3000	141000265..	135,00
2a Connettore di alimentazione	--	141000310..	21,00
2b Connettore di alimentazione riflesso	--	141000410..	21,00
4 Connettore ponte a scomparsa (per unire 2 barre)	--	141002510..	15,00
5 Connettore ponte flessibile	--	141002410..	103,00
6a Connettore ponte a "L"	--	141000510..	64,00
6b Connettore ponte a "L"	--	141000610..	64,00
7a Connettore ponte a "T"	--	141000810..	92,00
7b Connettore ponte a "T"	--	141000910..	92,00
7c Connettore ponte a "T"	--	141002110..	92,00
7d Connettore ponte a "T"	--	141002210..	92,00
8 Connettore ponte a "X"	--	141001010..	120,00
9 Tappo di chiusura	--	141002610..	4,00
10 Morsetto di sospensione	--	141002710..	27,00
11 Kit cavo di sospensione	--	141003310..	22,00

TRACK SYSTEM

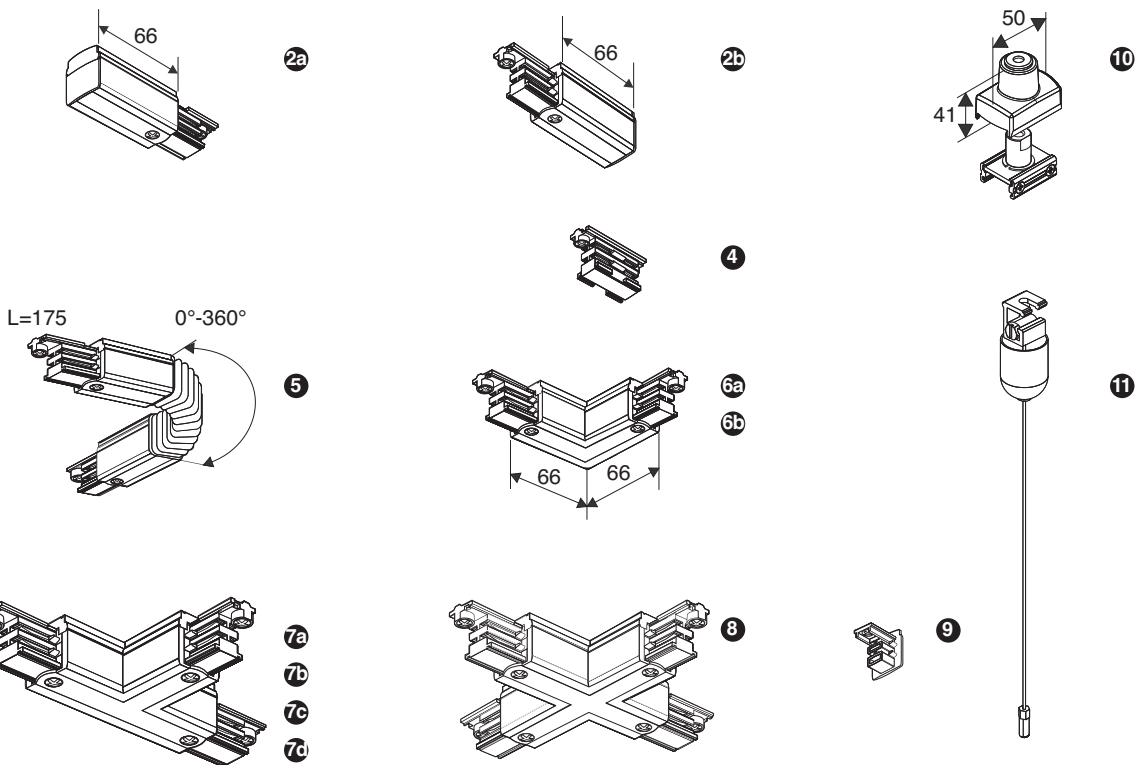
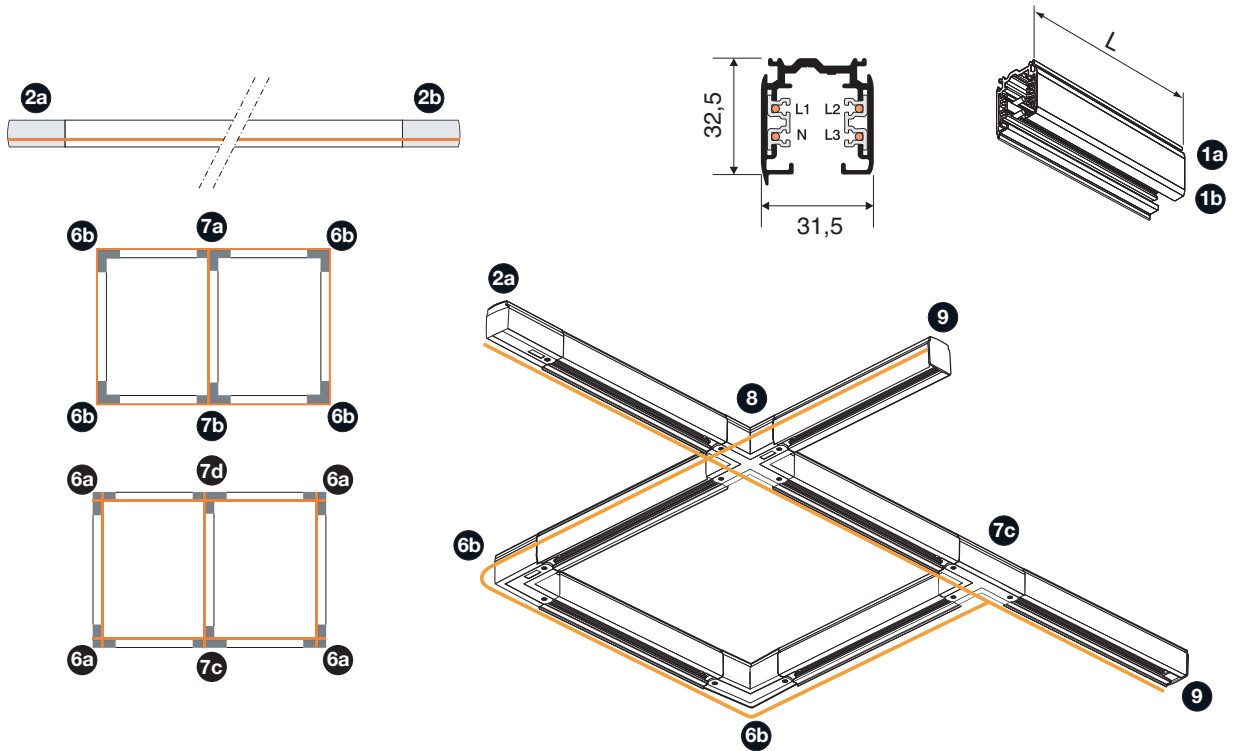

FARI DICROICI PER TRACK SYSTEM



EYES AR111 230 - 240 V

Faro alogeno omnidirezionale in alluminio verniciato completo di alimentatore elettronico, munito di connessione a binario.

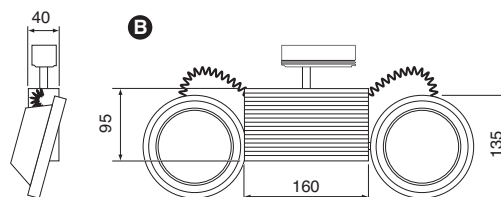
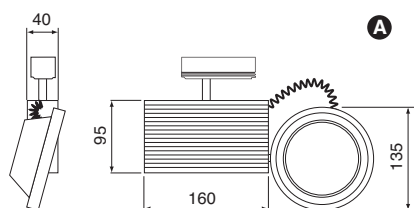

B	X2	W	colore	Art.	€
		2x50	grigio metallizzato	118002965..	184,00

FASCIO 230 - 240 V

Faro alogeno orientabile in metallo verniciato, munito di connessione per binario.

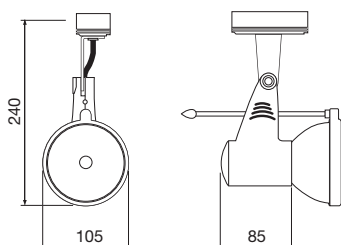

W	colore	Art.	€
100 max	grigio metallizzato	118015265	69,50

75 W	lampada alogena HI- SPOT	31200250000	20,00
100 W	lampada alogena HI- SPOT	2111800/SY	20,00



FARI AD ALOGENURI PER TRACK SYSTEM



EYES HQI-HCI 230 - 240 V

Faro ad alogenuri metallici omnidirezionale in alluminio verniciato completo di alimentatore elettronico, munito di connessione a binario.

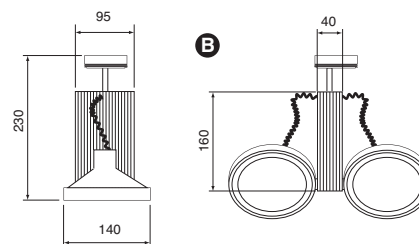
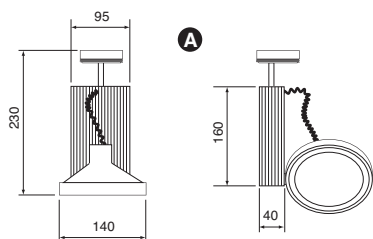

B X2 lampada	W	colore	Art.	€
	35x2	grigio metallizzato	118003165..	435,00
	35		31200080000	108,00

GEM HQI-HCI 230 - 240 V

Faro ad alogenuri metallici orientabile in alluminio verniciato, completo di alimentatore elettronico, munito di connessione per binario.

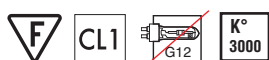
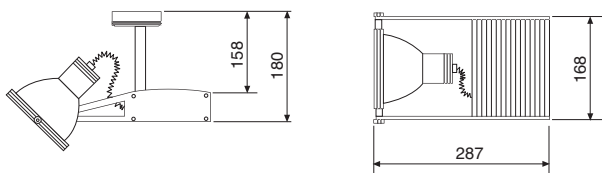

W	colore	Art.	€
70	grigio metallizzato	118003265..	315,00
70 W	lampada	31200050000	95,00



EVO I 230 - 240 V

Proiettore direzionabile da incasso in metallo verniciato per lampada alogena max 200W.

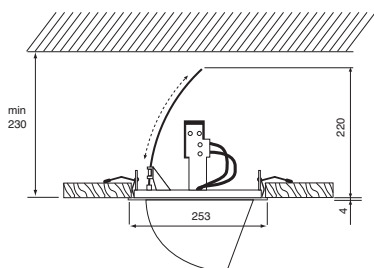

Foro incasso Ø 235 mm

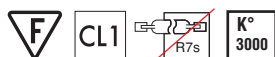

W	colore	Art.	€
200	grigio metallizzato	IT1613065/S	96,00
200	bianco	IT1613001/S	93,00
200	lampada	200T03Q/CL	10,00

EVO II 230 - 240 V

Proiettore direzionabile da incasso in metallo verniciato per lampada ad **alogenuri metallici** max 150W.

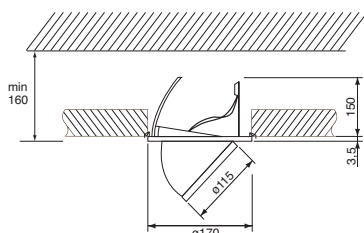

Foro incasso Ø 163 mm

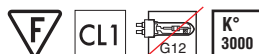

W	colore	Art.	€
max 150	bianco	118000701..	56,00
max 150	grigio metallizzato	118000765..	56,00
150	lampada	31200070000	95,00
70	lampada	31200050000	95,00

N.B. È SEMPRE NECESSARIO N° 01 ALIMENTATORE PER OGNI LAMPADA

HS- HI FEEDER

Alimentatore elettromagnetico per **lampade a scarica HCI-HQI.**

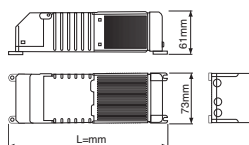

HS-HI	W	V	L=mm	Art.	€
HS-HI	70	230-240	222	125004300	85,00
HS-HI	150	230-240	250	125004400	92,00

POWERTRONIC PTU FEEDER

Alimentatore elettronico per **lampade a scarica HCI-HQI.**

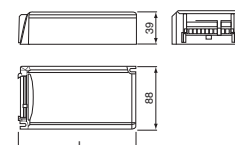

Powertronic PTU	W	V	L=mm	Art.	€
Powertronic PTU	70	230-240	161	125004200..	160,00
Powertronic PTU	150	230-240	190	125004800..	214,00

STUDIOS AR111 QUADRO 230 - 240 V

Faro alogeno omnidirezionale realizzato in metallo verniciato, completo di trasformatore elettronico 200W situato all'interno della staffa di fissaggio.

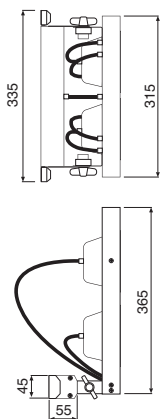

W	colore	Art.	€
4x50	grigio metallizzato	118001465..	341,00

lampada	50 W	2199100/IRC/OS	33,00
---------	------	-----------------------	--------------

STUDIOS AR111 LINEA 230 - 240 V

Faro alogeno omnidirezionale realizzato in metallo verniciato, completo di trasformatore elettronico 200W situato all'interno della staffa di fissaggio.

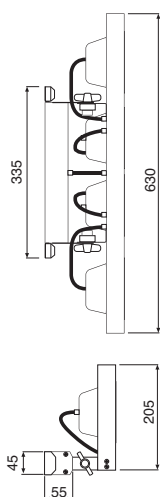

W	colore	Art.	€
4x50	grigio metallizzato	118001565..	341,00

lampada	50 W	2199100/IRC/OS	33,00
---------	------	-----------------------	--------------

STUDIOS DICRO QUADRO 230 - 240 V

Faro alogeno dicroico omnidirezionabile realizzato in metallo verniciato, completo di alimentatore elettronico 200W situato all'interno della staffa di fissaggio.

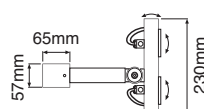
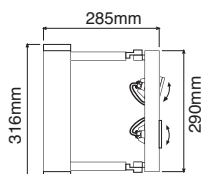

W	colore	Art.	€
4x50	grigio metallizzato	IT1601665	194,00 in esaurimento

lampada	20 W	215200	€ 7,00
lampada	35 W	215300	€ 7,00
lampada	50 W	215400	€ 7,00

STUDIOS DICRO LINEA 230 - 240 V

Faro alogeno dicroico omnidirezionabile realizzato in metallo verniciato, completo di alimentatore elettronico 200W situato all'interno della staffa di fissaggio.

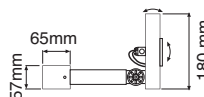
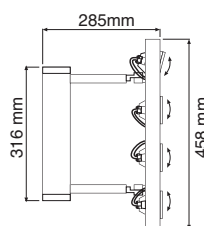

W	colore	Art.	€
4x50	grigio metallizzato	IT1601765	194,00 in esaurimento

lampada	20 W	2152000	€ 7,00
lampada	35 W	215300	€ 7,00
lampada	50 W	215400/	€ 7,00

PROIETTORI DA INCASSO

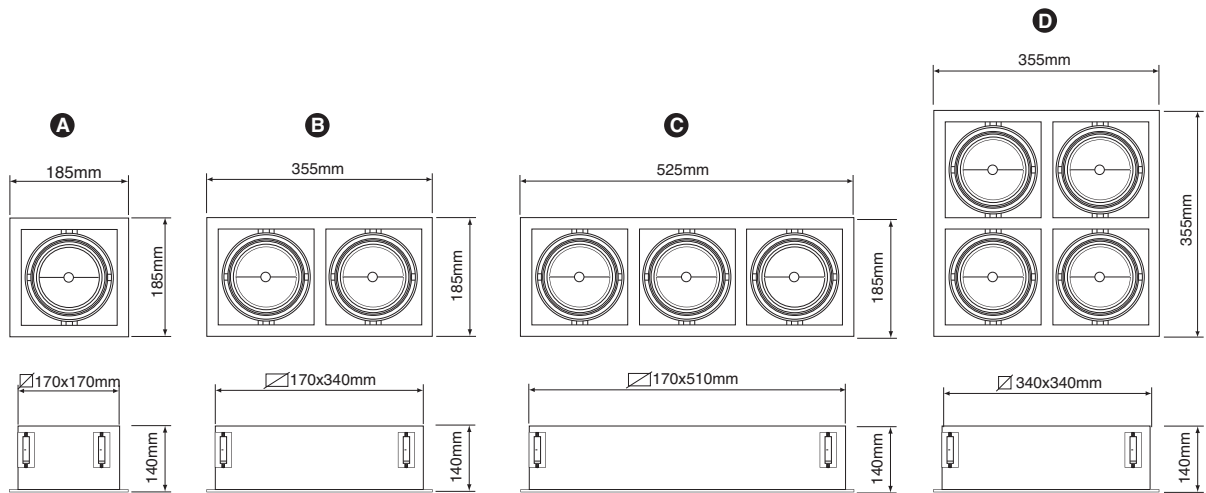

STUDIOS AR111 12 V

Faro alogeno da incasso omnidirezionale realizzato in metallo verniciato.



	W	colore	Art.	€
A X1	50	grigio metallizzato	118001865..	49,00
B X2	50x2	grigio metallizzato	118001965..	92,00
C X3	50x3	grigio metallizzato	118002065..	144,00
D X4	50x4	grigio metallizzato	118002165..	176,00

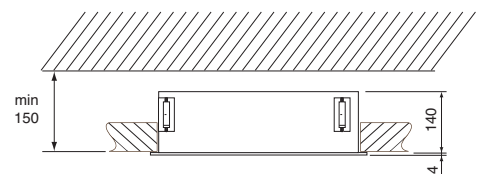

lampada | 50 W | **2199100/IRC/OS** | € 33,00

trasform. set 210 | 50/210 W | **N1700303/S** | € 42,00

PROIETTORI DA INCASSO

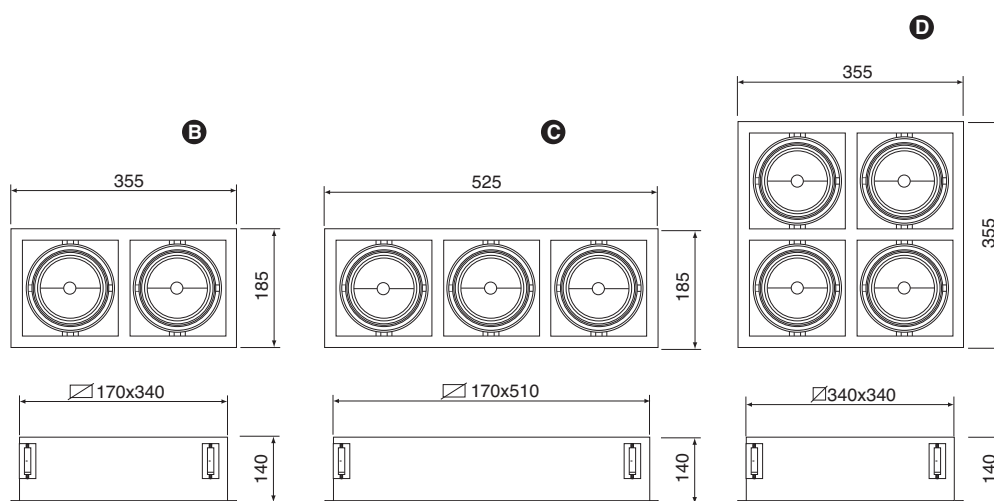

STUDIOS PAR 230 - 240 V

Faro alogeno da incasso omnidirezionale realizzato in metallo verniciato.



	W	colore	Art.	€
B X2	2x75	grigio metallizzato	118014965..	150,00
C X3	3x75	grigio metallizzato	118015065..	228,00
D X4	4x75	grigio metallizzato	118015165..	272,00

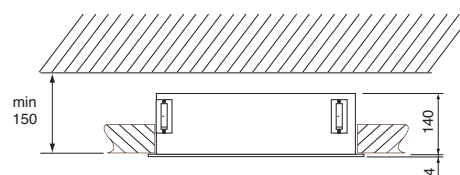

lampada | 50 W | 2110300/OS | € 13,00

PROIETTORI DA INCASSO

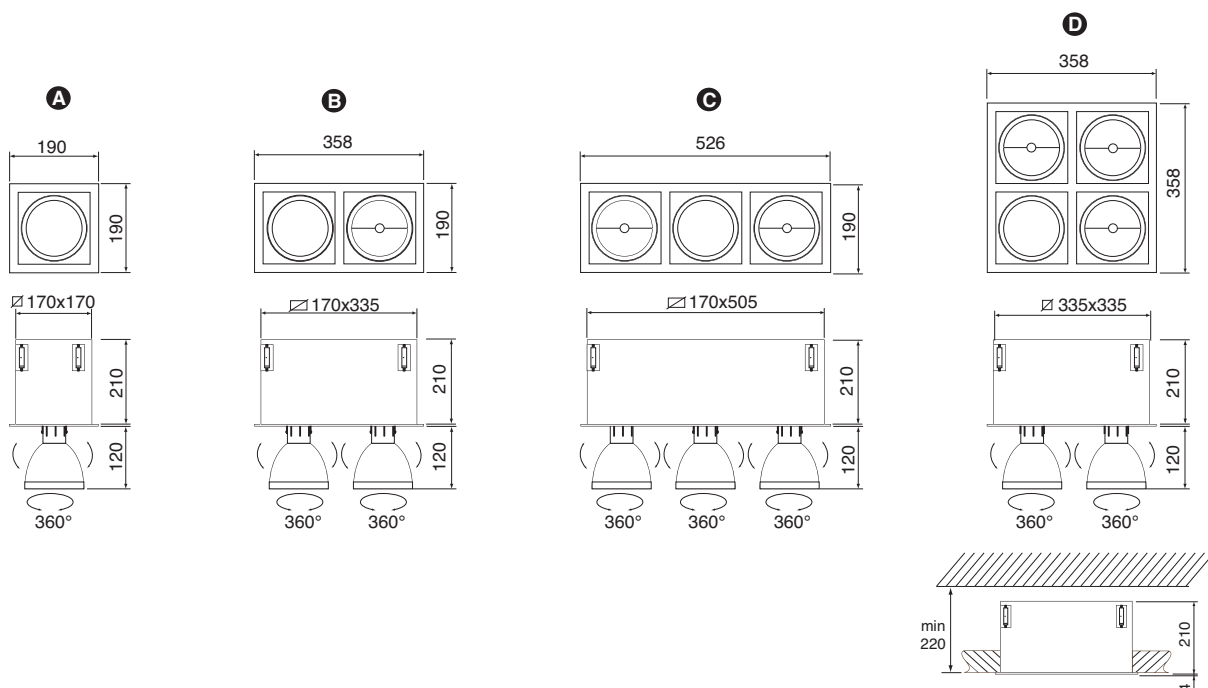

STUDIOS FLEX 230-240 V

Faro in metallo verniciato, combinabile (alogeno + ioduri metallici), estensibile ed omnidirezionale, con gli elementi illuminanti rotabili a 360°.



		W	colore	Art.	€	
A	X1	HQI	70	grigio metall.	118014165	85,00
B	X2	1 HQI + 1 AR	70 + 65 (resa 100)	grigio metall.	118014265	140,00
C	X3	1 HQI + 2 AR	70 + 2x65 (resa 100)	grigio metall.	118014365	195,00
D	X4	1 HQI + 3 AR	70 + 3x65 (resa 100)	grigio metall.	118014465	254,00

lampada	W	Art.	€
alogeno	50	2199100/IRC/OS	33,00
alogenuri	70	31200050000	98,00

Necessita sempre di un alimentatore per lampada HQI.
Vedi pag.

LAMPADE ALOGENE DICROICHE

Ø 50 mm

Ø 35 mm



12V	con vetro	Ø mm	Watt	attacco	€
215500		35	20	GU4	9,00
215200		50	20	GU5,3	7,00
215300		50	35	GU5,3	7,00
215400		50	50	GU5,3	7,00

220/230V	con vetro	Ø mm	Watt	attacco	€
2110300/OS		50	50	GU10	15,00

75 W	lampada alogena HI- SPOT	31200250000	E27	20,00
100 W	lampada alogena HI- SPOT	2111800/SY	E27	20,00

LAMPADE ALOGENE



12V	Art.	Watt	Lumen	attacco	€
	217800	10	140	G4	2,00
	211300	20	300	G4	2,00

220V	Art.	Watt	Lumen	attacco	€
	2111500/OS	40	490	G9	9,00

LAMPADE

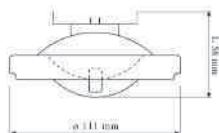

ALOGENE

CON RIFLETTORE IN ALLUMINIO

Art.	Watt	attacco	gradi	€
2199100/IRC/OS	50	G53	24°	34,00
2199300/OS	100	G53	24°	29,00
31200010000	65	G53	24°	34,00

LAMPADE FLUORESCENTI

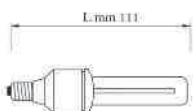

Fluorescente compatta elettronica	tonalità K.	Art.	Watt	Lumen	attacco	€
	2.700	FPLE7W/LE	7	400	E14	23,00

TUBI FLUORESCENTI Ø 16 MM T5



	tonalità K.	Art.	Watt	Lumen	attacco	lunghezza	€
alta resa	4.000	FL 8W/20	8	385	G5	288	3,00
	2.700	FL 8W/41	8	450	G5	288	4,00
alta resa	4.000	FL 13W/20	13	830	G5	517	5,00
	2.700	FL 13W/41	13	950	G5	517	6,00
	4.000	31000070100	14				12,00
	4.000	FFH 21W/840	21	2100	G5	849	15,00
	3.000	FFH 21W/830	21	2100	G5	849	15,00
	4.000	FFH 28W/840	28	2900	G5	1149	16,00
	3.000	FFH 28W/830	28	2900	G5	1149	16,00
	4.000	31000010100	35				16,00